

**ENVIRONMENTAL ASSESSMENT
& EFFLUENT LIMIT DERIVATION REPORT
for THE AMMONIA DISCHARGE
from THE CITGO LEMONT REFINERY**

for
CITGO Lemont Refinery
135th Street and New Avenue
Lemont, Illinois

Prepared by:

**James E. Huff, P.E.
Margaret A. Panatera, P.E.**

February 2008



TABLE OF CONTENTS

	Page
1. INTRODUCTION	1
2. BACKGROUND INFORMATION.....	3
2.1 Site Description	3
2.2 Production Trends	3
2.3 Description of Wastewater Treatment Facility.....	6
2.4 Applicable Regulations.....	6
2.5 Mixing Zone	9
3. INFLUENT AND EFFLUENT WATER QUALITY	10
3.1 Introduction.....	10
3.2 Effluent Quality.....	10
3.3 Influent Ammonia Levels	13
3.4 Net Ammonia Loading.....	13
4. CHICAGO WATERWAY AND ILLINOIS RIVER SYSTEM WATER QUALITY	16
4.1 Introduction.....	16
4.2 USGS/IEPA Waterway Monitoring.....	17
4.3 Metropolitan Water Reclamation District of Greater Chicago Waterways Data	18
4.4 Midwest Generation Data	27
4.5 IEPA Waterway Classification/Assessment.....	30
5. DERIVATION OF EFFLUENT LIMITS.....	31
6. SUMMARY	34

LIST OF FIGURES

FIGURE 2-1 Site Location Map	4
FIGURE 2-2 The Chicago Waterway and Upper Illinois River System.....	5
FIGURE 2-3 Process Flow Diagram of Existing Wastewater Treatment Facilities	7
FIGURE 3-1 Annual Average Effluent Ammonia Concentration, Lemont Refinery.....	11
FIGURE 3-2 Ammonia Effluent Loading, Lemont Refinery.....	12
FIGURE 3-3 Annual Average Influent Ammonia Concentrations, Sanitary & Ship Canal	14
FIGURE 3-4 Annual Average Ammonia Influent and Effluent Loading	15

LIST OF TABLES

TABLE 4-1 Total Ammonia, NH ₃ /N, mg/L.....	19
TABLE 4-2 Un-Ionized Ammonia, mg/L.....	23
TABLE 4-3 Metropolitan Water Reclamation District of Greater Chicago Des Plaines River Data for 2000 from Lockport to I-55.....	28
TABLE 4-4 Midwest Generation EME, LLC Lower Des Plaines River at I-55 Bridge Monthly Minimum Dissolved Oxygen Concentration.....	29

LIST OF APPENDICES

- A NPDES General Permit No. IL0001589
- B Lemont Refinery Data – 1997 to 2007
- C USGS and MWRDGC Data – 1999 to 2006
- D Statistical Analysis – Existing Effluent Data

ABBREVIATIONS AND ACRONYMS

BAT	Best Available Technology Economically Achievable
BOD5	five-day biochemical oxygen demand
degrees F	degrees Fahrenheit
D.O.	dissolved oxygen
EPA	Environmental Protection Agency
IAC	Illinois Administrative Code
IEPA	Illinois Environmental Protection Agency
IPCB	Illinois Pollution Control Board
ISWS	Illinois State Water Survey
lb/day	pounds per day
MGD	million gallons per day
mg/L	milligrams per liter
MWRDGC	Metropolitan Water Reclamation District of Greater Chicago
NPDES	National Pollutant Discharge Elimination System
PCB	polychlorinated biphenyl
PTU	purge treatment unit
TSS	total suspended solids
UAA	Use Attainability Analysis
USGS	United States Geological Survey

1. INTRODUCTION

CITGO Petroleum Corporation (Citgo) currently operates a petroleum refinery near Lemont, Illinois. Lemont Refinery was formerly owned by UNO-VEN Company. On May 1, 1997, PDV Midwest Refining, L.L.C. purchased Lemont Refinery from UNO-VEN and contracted with CITGO to operate the refinery.

Wastewater treatment at Lemont Refinery includes physical/chemical and biological treatment processes. The treatment plant includes primary, secondary, and tertiary treatment of the wastewater prior to discharge into the Chicago Sanitary and Ship Canal (Ship Canal). The Ship Canal is part of the Chicago Waterway classified as a Secondary Contact Water under Title 35: Subtitle C: Chapter 1 of the Illinois Administrative Code. The Illinois Pollution Control Board (IPCB) adopted Title 35: Part 304.122 to limit ammonia discharges to the Chicago River System. Rule 304.122(b) restricts larger industrial discharges (greater than 100 lbs/day ammonia) to a 3.0 mg/L monthly average limit and 6.0 mg/L daily maximum.

The IPCB has established water quality standards for state waters, including the Chicago Waterways to further protect water quality. The Secondary Contact Water Quality Standard for ammonia is 0.1 mg/L of un-ionized ammonia. There is no water quality limit on total ammonia levels in Secondary Contact Waters. The Illinois EPA in October 2007 submitted a proposal to the IPCB to significantly change the water quality standards on the *Secondary Contact* waterways, including ammonia nitrogen. The proposed change in the ammonia water quality standard would basically bring the water quality standards on the *Secondary Contact* waterways to the same levels as the *General Use* waterways. This same proposal also proposes to delete the current total dissolved solids (TDS) water quality limit, and add a sulfate water quality standard that is consistent with that proposed for *General Use* waterways.

The U.S. EPA has established effluent guidelines for wastewater discharges by industry category. The petroleum refining industry is divided into five subcategories based upon the processes utilized and the products produced. Lemont Refinery, under the federal regulation, is classified as a Subcategory-B,

upon production, and are computed on a pounds per day basis. The refinery has historically achieved compliance with the federal effluent guidelines; however, the 3.0 mg/L / 6.0 mg/L state effluent limit has not been attainable on a continual basis.

In 1988 Lemont Refinery was granted a site-specific standard for effluent ammonia limits to gain relief from the 3.0 mg/L state effluent limit, as set forth in 35 IAC 304.213. The initial rule change required the refinery to meet the applicable BAT load limitations as follows:

Monthly Average Limit	749 lb/day
Daily Maximum Limit	1,648 lb/day

Two subsequent rule changes shifted the effluent limits to concentration-based standards. The current rule limits the refinery to the following ammonia effluent limits:

Monthly Average Limit	9.4 mg/L
Daily Maximum Limit	26.0 mg/L

The concentration limits have been incorporated into the refinery's current NPDES permit (IL0001989). A copy of the NPDES permit is provided in Appendix A. The provisions granting the site-specific ammonia limits terminate December 31, 2008.

The purpose of this report is to assess the environmental impact of the ammonia in Lemont Refinery's wastewater effluent. Effluent limits are derived based upon existing effluent quality, BAT, and current water quality conditions on the Ship Canal. These limits are compared to the existing concentration limits contained in the NPDES permit and new limits are proposed herein.

2. BACKGROUND INFORMATION

2.1 Site Description

Lemont Refinery is located southwest of Lemont, Illinois and east of Romeoville, as depicted in Figure 2-1. The Chicago Sanitary and Ship Canal (Ship Canal) is situated to the north and west of the refinery. The Ship Canal runs parallel to the Des Plaines River, generally flowing southwest at this location.

The Chicago Waterway is part of the Corps of Engineer river mile system. River mile point 0.0 is the confluence of the Illinois River and the Mississippi River in Grafton, Illinois. Lemont Refinery's outfall 001 is located at river mile 296.5 on the Ship Canal, 5.5 miles upstream of the Lockport Lock and Dam. The Chicago Waterway and Illinois River are shown on Figure 2-2.

2.2 Production Trends

Lemont Refinery refines domestic and foreign crude oil to produce gasoline, kerosene, home heating oil, aviation fuel, diesel oil, petrochemical solvents, and petroleum coke. Refining of crude oil includes the removal of nitrogen and sulfur compounds through distillation, desalting, and fractionation processes. The nitrogen that is removed during the refining process typically ends up in an aqueous waste stream, along with sulfur compounds (sulfides). The various sulfur and nitrogen-bearing waste streams are processed through four sour water strippers at the refinery to remove the sulfides and ammonia from the wastewater prior to discharge to the process wastewater system.

Crude throughput over the last ten years peaked in 2003 at an annual average of 162,353 bbls/day. Nitrogen content of the crude oil has a bearing on ammonia loading in the wastewater. Nitrogen content in the late 1990's and early 2000's remained fairly consistent near 0.20 percent. Between 2004 and 2006 nitrogen content declined approximately 10 percent to 0.18 percent.

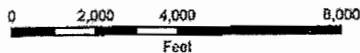
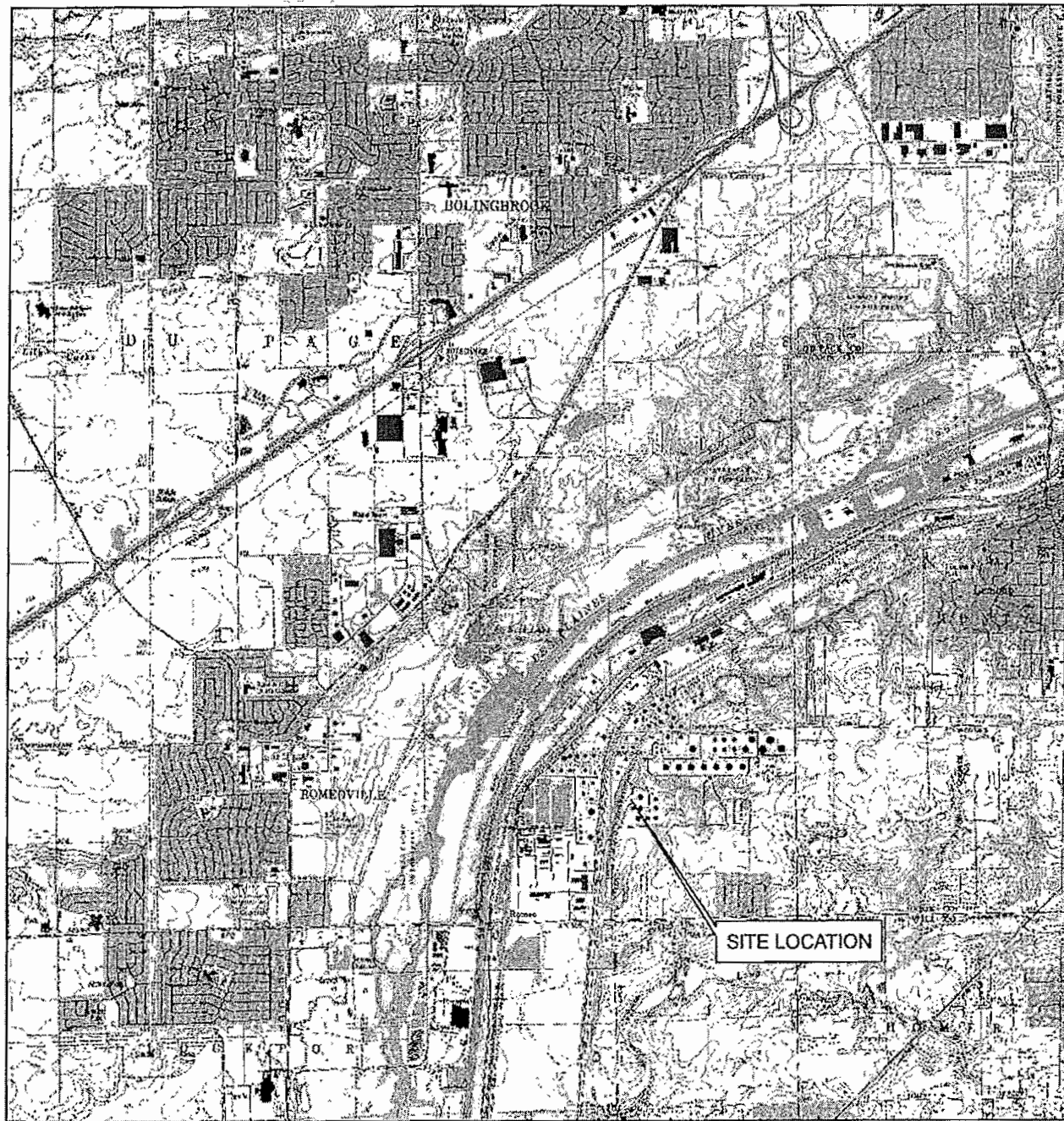

**FIGURE 2-1
SITE LOCATION MAP
LEMONT REFINERY
LEMONT, ILLINOIS**

SOURCE: UNITED STATES DEPARTMENT OF THE INTERIOR, GEOLOGICAL SURVEY
ROMEDEVILLE, ILLINOIS QUADRANGLE

CADEFILE: CITGO TOPO

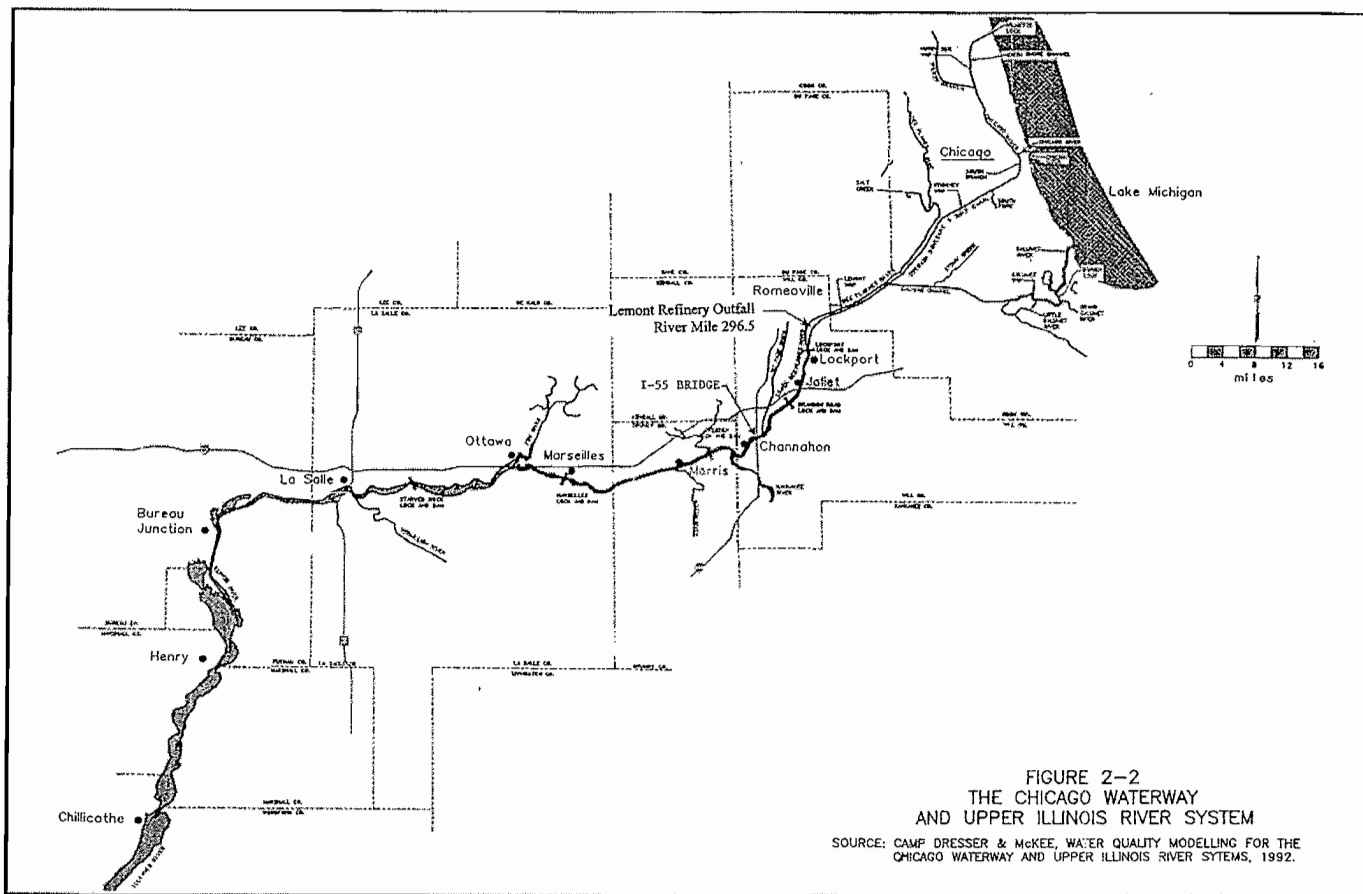

A challenge to ammonia treatment is the change in feedstock in recent years. The processing of heavier crude oil has introduced significant increased solids and oil loadings on the wastewater treatment system, causing difficulty in maintaining nitrification.

2.3 Description of Wastewater Treatment Facility

The wastewater treatment plant at the refinery began operation in 1969. The original design included two oil-water separators, a flow equalization tank, a primary clarifier, activated sludge system, and a polishing pond prior to discharge. Several wastewater treatment plant modifications have been made since the original installation. Figure 2-3 depicts the process as it currently exists. Major changes to the system prior to 1992 included new process water storage tanks, new oil/water separators, a new aeration basin, a new clarifier, and fine bubble diffusers.

The stormwater basin was segregated from the process wastewater in 1992. The stormwater basin now receives stormwater, hydrostatic test and fire water, utility, boiler blowdown and site tenant (Chicago Carbon, Kinder Morgan, BOC) storm water. This segregation eliminated the bypass of pretreatment of process wastewater during heavy flow. The segregation of the storm water basin cost \$20,900,000. To clean close the basins after the streams were segregated, the Refinery spent an additional \$9,400,000.

Additional modifications/upgrades for the wastewater treatment system in the last ten years include: induced gas flotation (with polymer addition) in 2000, additional strippers in the sour water system in 2003, upgrading diffused aerators in Cell B in 2003, upgrading the feed system for phosphoric acid in 2006, upgrading diffused aerators in Cell A in 2006, a purge treatment unit (PTU) for scrubber discharge in 2007, and upgrading diffused aerators in Cell C in 2007. According to the current NPDES permit (Appendix A), the design average flow for outfall 001 is 5.79 MGD.

2.4 Applicable Regulations

Lemont Refinery discharges effluent from its wastewater treatment plant into the Ship Canal. The plant's discharge quality is limited under a NPDES permit (IL0001589) issued by the Illinois EPA.

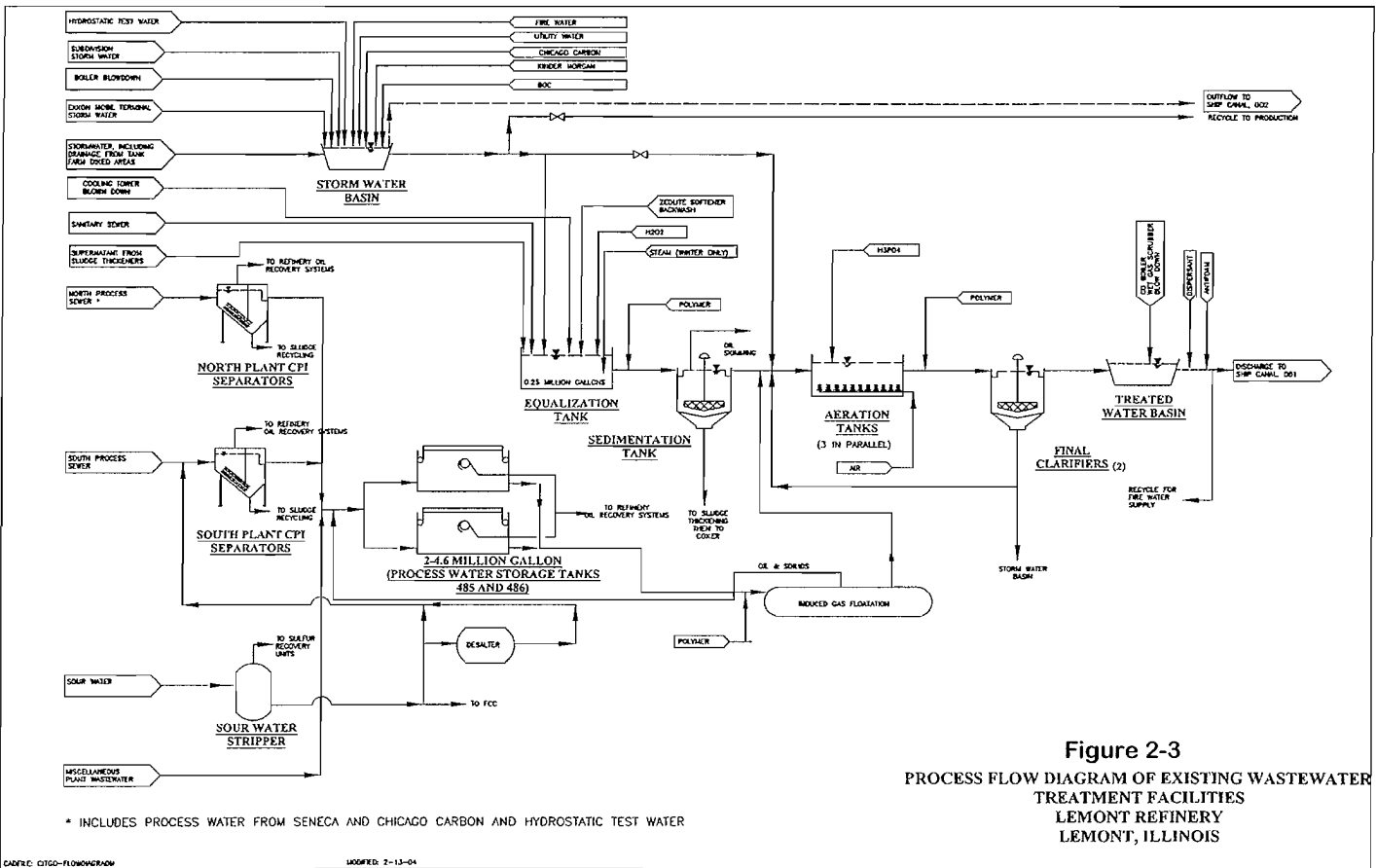

Figure 2-3
 PROCESS FLOW DIAGRAM OF EXISTING WASTEWATER
 TREATMENT FACILITIES
 LEMONT REFINERY
 LEMONT, ILLINOIS

The Ship Canal is classified as a Secondary Contact Water under Title 35: Environmental Protection; Subtitle C: Water Pollution; Chapter I: Pollution Control Board; Part 303; Subpart C. The regulations establish water quality standards for Secondary Contact Waters under Part 302; Subpart D. Water quality standards are generally established as maximum limits; no discharger shall discharge effluent such that it causes the receiving stream to exceed a water quality standard, after mixing. Section 302.407 limits the water quality for un-ionized ammonia concentration in a Secondary Contact Water to 0.1 mg/L.^{1/}

The Illinois regulations also include general effluent limitations for discharges to State Waters. These standards are given in Part 304: Effluent Standards; Subpart A: General Effluent Standards. Section 304.122 contains the effluent standards for ammonia discharges. For discharges to the Illinois River System, whenever the monthly average ammonia as N exceeds 100 pounds per day, there is a 3.0 mg/L effluent monthly average effluent limit. In addition, whenever the daily ammonia as N discharge exceeds 200 pounds per day, there is a 6.0 mg/L effluent limit. Without the existing site-specific rule change, the monthly average limit for Lemont Refinery would be 3.0 mg/L, with a daily maximum limit of 6.0 mg/L whenever the above mass limits are exceeded.

In addition to the State limitation, Lemont Refinery is required to achieve Best Available Technology Economically Achievable (BAT) limits promulgated by U.S. EPA in 40 CFR 419.23. The applicable BAT limitations are based on crude oil throughput. The BAT limits for ammonia are 1,005.75 lbs/day monthly average and 2,212.65 lbs/day daily maximum, as contained in the facility's NPDES permit.

The last site-specific relief from the 3.0/6.0 mg/L ammonia effluent limits the refinery was granted occurred in 1998. Site-specific ammonia effluent limits were established based upon existing effluent quality at 9.4 mg/L and 26.0 mg/L for the monthly average and daily maximum, respectively. The current NPDES permit, IL0001589, under which the Lemont Refinery is operating, expires July 31, 2011. The site-specific rule change with effluent limits of 9.4 mg/L and 26.0 mg/L for monthly average and daily maximum, respectively, expires December 31, 2008.

^{1/} The Agency recently submitted proposed water quality revisions on the Ship Canal to the Pollution Control Board, and the impact of these proposed changes on the Lemont Refinery is discussed in Section 4.4.

2.5 Mixing Zone

The mixing zone is an integral part of the State's water quality protection program. Mixing Zone is defined in Title 35; Subtitle C; Chapter I; Part 302; Subpart A; Section 302.100 as:

“‘Mixing zone’ means a portion of the waters of the State identified as a region within which mixing is allowed pursuant to Section 302.102(d).”

According to Section 302.101(a), Part 302 “contains schedules of water quality standards which are applicable throughout the State as designated in 35 Ill. Adm. Code 303”. Secondary Contact Waters are designated in Part 303, Section 303.411.

Section 302.102 defines allowable mixing zone areas. Section (b)(8) limits area or volume of the mixing zone to 25 percent of the cross sectional area or volume of stream flow, except for streams with a dilution ratio less than 3:1. Lemont Refinery's design average effluent flow is 5.79 MGD, compared to the Ship Canal's 7-day, 10-year low flow of approximately 1,315 cfs or 850 MGD (ISWS 7Q10 Maps, February 2003 Rev). This ratio (147:1) is clearly greater than 3:1. The width of the Ship Canal at outfall 001 is 172 feet; therefore the mixing zone allowed would be no wider than 43 feet and the available upstream flow of 25 percent of the low flow, or 0.25×850 MGD or 212.5 MGD.

Section 302.102(b)(12) limits the mixing zone to 26 acres (1,132,560 square feet). Assuming the entire length of the mixing zone was 43 feet wide, the Lemont Refinery would be allowed a maximum mixing zone length of 26,340 feet downstream direction (5 miles) in length.

U.S. EPA has issued a guidance document entitled “Technical Support Document for Water Quality-based Toxic Control” (U.S. EPA, 1991). In general, the U.S. EPA policy specifies the water quality standards be achieved at the edge of the mixing zone. Therefore, the un-ionized ammonia water quality standard of 0.1 mg/L is to be achieved at the edge of the mixing zone.

The recently proposed water quality revisions R08-9) are based on the recent Use Attainability Analysis (UAA). These proposed changes do not modify the applicable mixing zone regulations.

3. INFLUENT and EFFLUENT WATER QUALITY

3.1 Introduction

Lemont Refinery produces a range of industrial products (coke, sulfur, etc.), solvents (aliphatic and aromatic), and conventional and reformulated petroleum products, including gasoline, distillates, and jet fuel. Since 1977, Lemont Refinery has implemented a variety of in-plant and end-of-pipe programs to reduce effluent ammonia loadings. These efforts and resultant effluent quality are described below.

3.2 Effluent Quality

Several factors influence the ammonia nitrogen concentration in the effluent including nitrogen content in the crude oil; crude oil throughput; influent BOD₅, TSS, and oil loadings; and degree of nitrification being achieved in the wastewater treatment plant. Figure 3-1 presents the annual average effluent ammonia concentrations since 1997. (Appendix B presents tabulated effluent data for the last ten years.)

The annual average flow rate for the wastewater treatment system has remained fairly consistent, between 3.5 MGD and 4.7 MGD from 1997 to 2006. From 2003 to 2006, the effluent flow has ranged from an average of 4.3 MGD to 4.7 MGD.

Ammonia loading from the Lemont Refinery's discharge to the Ship Canal is a function of both the ammonia concentration and effluent flow rate. Figure 3-2 presents the annual average ammonia loadings (in pounds per day) from 1997 to 2006. On an annual basis, the refinery has consistently discharged less than 140 pounds per day. In fact, over 70 percent of the months the Lemont Refinery has discharged less than 100 pounds per day of ammonia, so the 3 mg/L effluent limit would not apply during these months, if the site specific standard were not in place.

Figure 3-1
ANNUAL AVERAGE EFFLUENT AMMONIA CONCENTRATION
Lemont Refinery

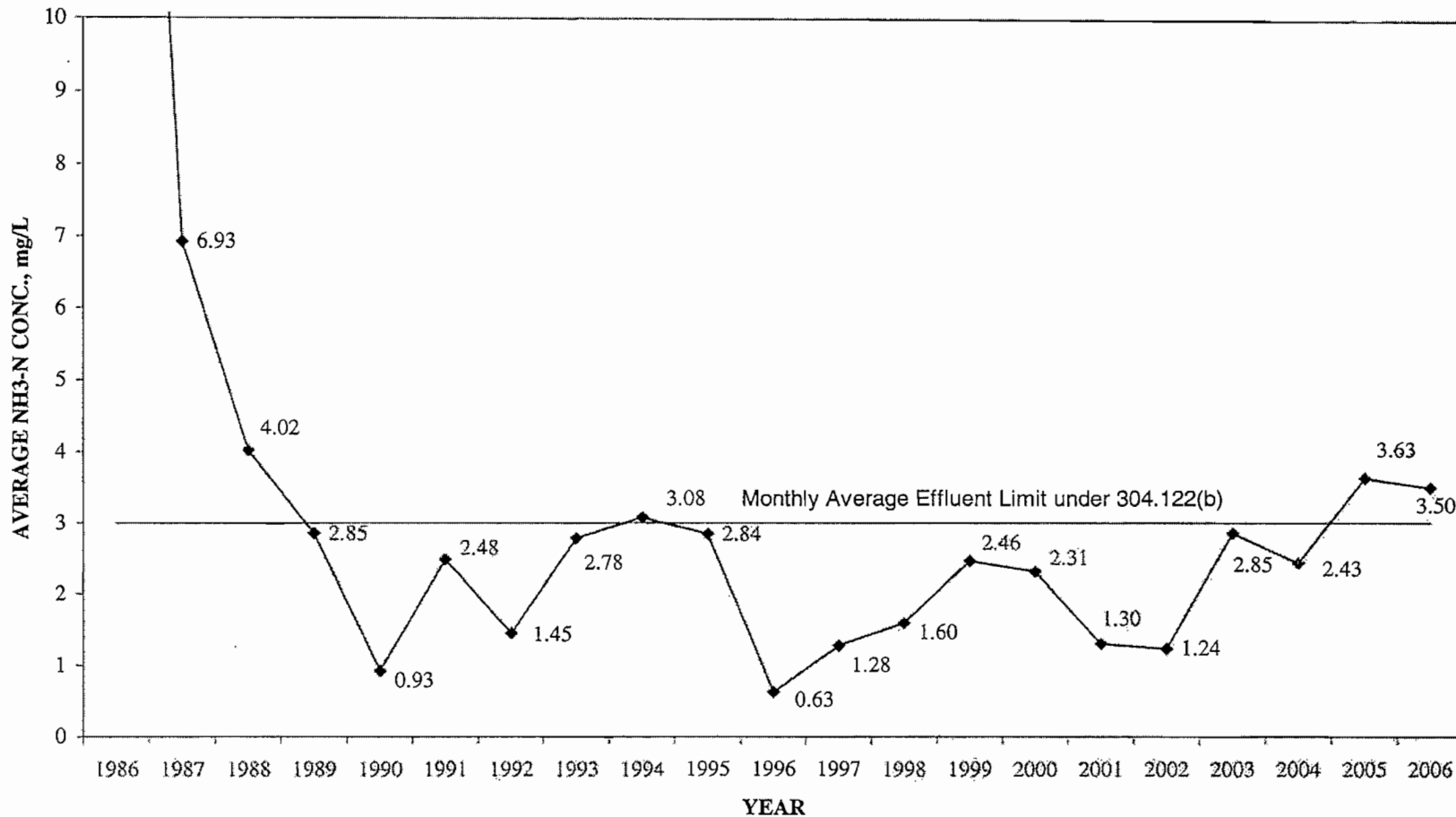
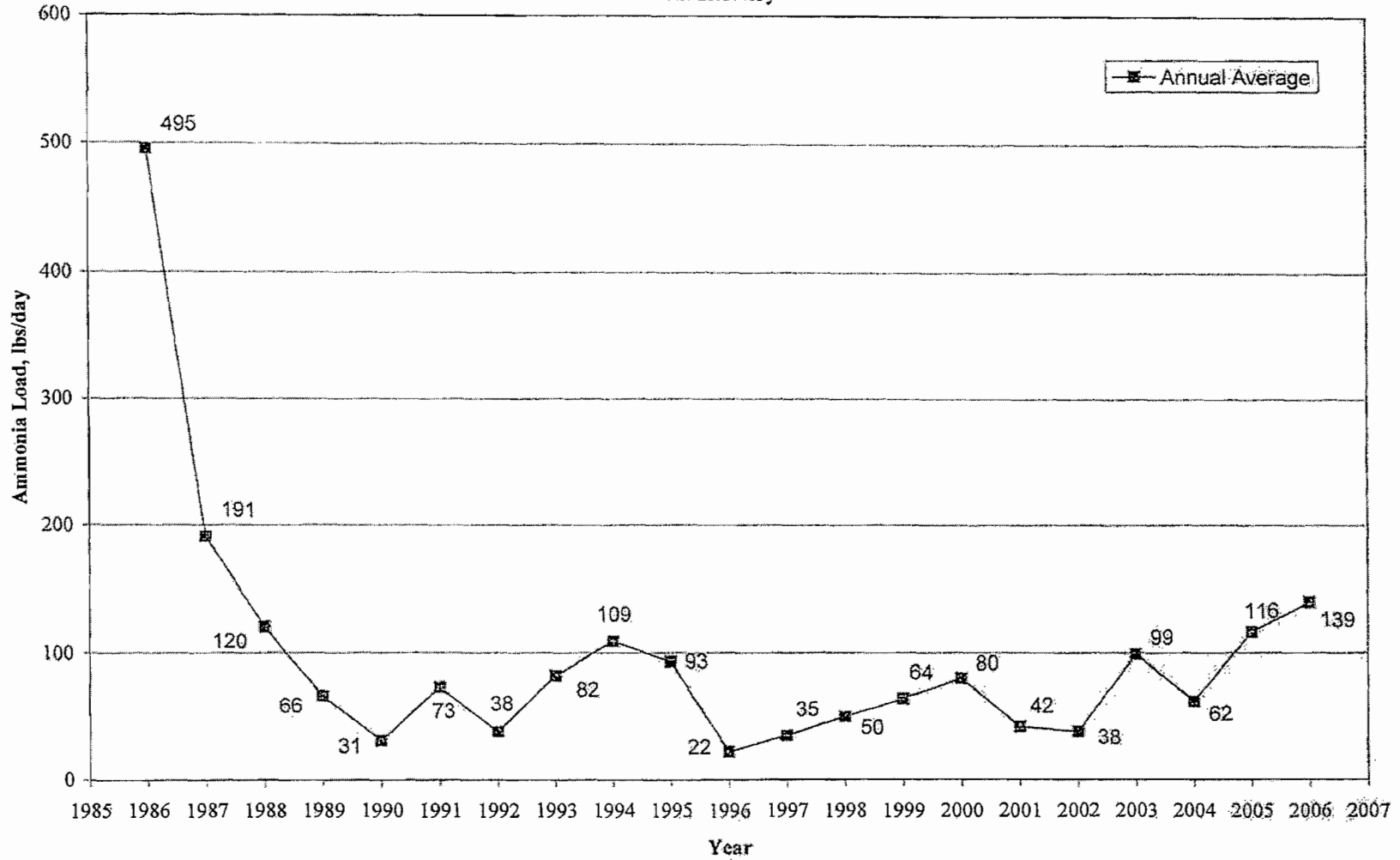

Figure 3-2
AMMONIA EFFLUENT LOADING
Lemont Refinery



3.3 Influent Ammonia Levels

Lemont Refinery withdraws water from the Ship Canal as its primary water source. The intake is upstream of the wastewater treatment plant outfall and is therefore not affected by effluent concentrations. The flow rate of the influent is higher than that of the effluent. The annual average intake has varied between 4.5 MGD and 5.6 MGD from 1997 to 2006. The reduction in flow rate through the Refinery is due to evaporation losses from the cooling towers.

Figure 3-3 presents the average ammonia concentration in the intake water. A general declining trend is apparent since 1999. The average Ship Canal concentration has declined to 0.7 mg/L in 2006.

3.4 Net Ammonia Loading

Since 1997, Lemont Refinery has withdrawn an average of 32.8 lbs/day ammonia from the Ship Canal compared to an average of 72.5 lbs/day discharged. The ammonia in the water drawn from the Ship Canal represents 45 percent of the ammonia discharged over the past decade. Thus, the net ammonia contributed by the refinery over the past decade has averaged 39.7 pounds per day. Figure 3-4 presents the annual average effluent and influent loading for ammonia at the Lemont Refinery.



Figure 3-3
ANNUAL AVERAGE INFLUENT AMMONIA CONCENTRATION
Sanitary & Ship Canal

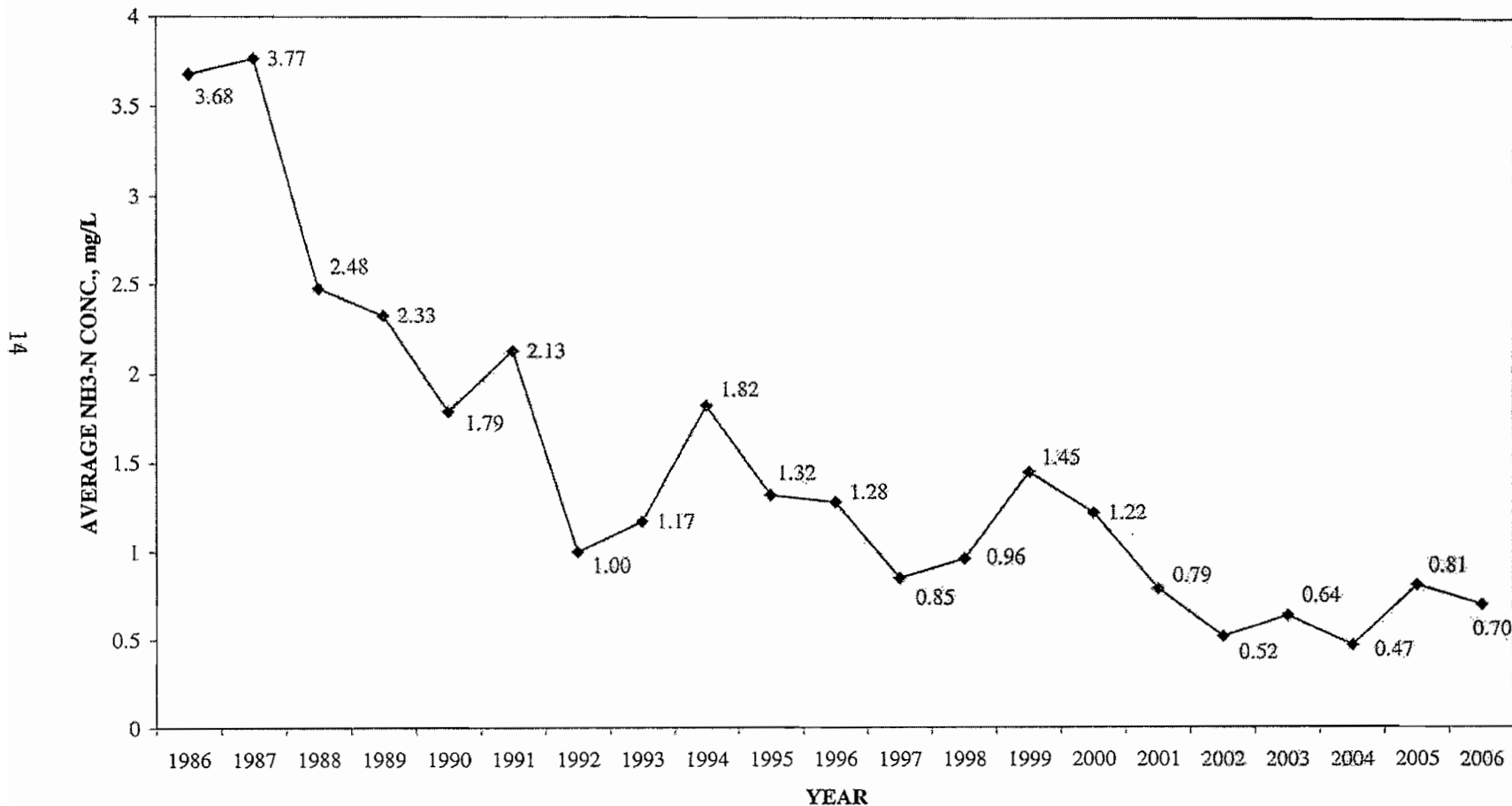
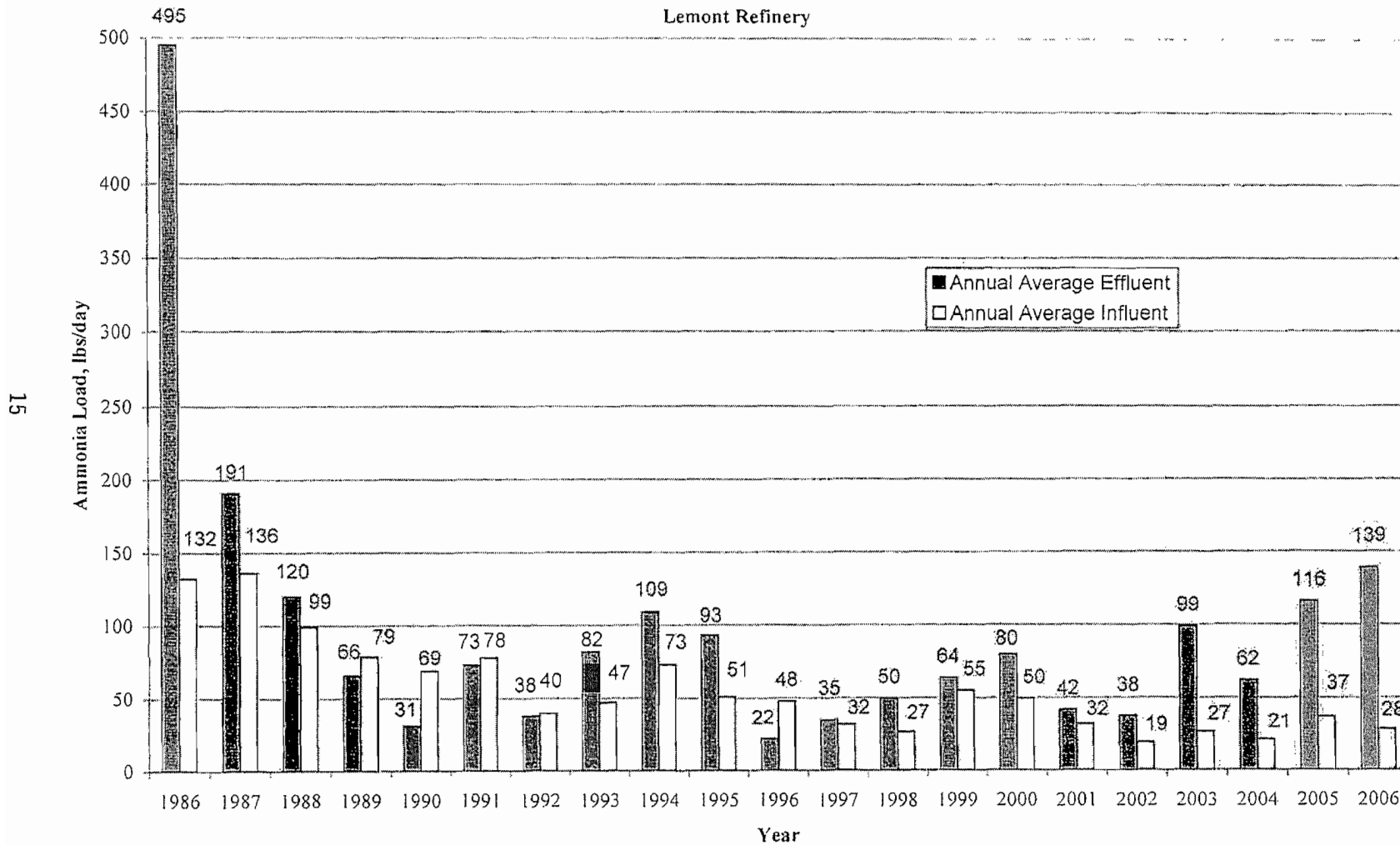

Figure 3-4
ANNUAL AVERAGE AMMONIA INFLUENT AND EFFLUENT LOADING
Lemont Refinery



4. CHICAGO WATERWAY and ILLINOIS RIVER SYSTEM WATER QUALITY

4.1 Introduction

The wastewater discharge from Lemont Refinery into the Ship Canal occurs 5.5 miles upstream of the Lockport Lock and Dam at river mile 296.5. The existing water quality conditions with respect to ammonia and dissolved oxygen are described herein, followed by discussion of impacts to the river basin. Historical trends in water quality are provided. The river system has been monitored by the Illinois EPA, the Metropolitan Water Reclamation District of Greater Chicago (MWRDGC), and the U. S. Geological Survey (USGS), and Midwest Generation, LLC.

The Ship Canal receives treated domestic wastewater from three major water reclamation plants, combined sewer overflows, non-point source runoff, and numerous smaller municipal discharges and industrial discharges. The combination of these sources affects the quality of water in the Ship Canal, as does the physical shape of the Ship Canal. The Chicago Waterway has been designated *Secondary Contact* waterway up to the Des Plaines River at the I-55 Bridge. Figure 2-2 depicted the location of the three major water reclamation plants and Lemont Refinery. The water quality standards for *Secondary Contact* waterways are intended to protect the indigenous aquatic life and secondary contact uses. Parameters important to this study have the following water quality standards (established in 35 IAC 302):

Un-ionized Ammonia	0.1 mg/L (maximum)
pH	6.0 to 9.0 standard units
Dissolved Oxygen	4.0 mg/L (minimum)
Temperature	37.8°C (maximum)

In October 2007, the Agency filed R08-09 before the IPCB to amend the water quality standards on the *Secondary Contact* waterways. The proposed changes include amending the ammonia water quality standards to be similar to the General Use ammonia water quality standards found in 302.212(e). For the Ship Canal, the early life stage present water quality limits do not apply due to the absence of spawning

the absence of spawning fish. The Agency's Statement of Reason includes an economic justification section that identifies temperature as the only proposed change on the Ship Canal that will cause economic impact. This would imply that the Ship Canal is currently meeting the proposed ammonia water quality limits, which is consistent with the available water quality data presented below.

The D.O. water quality standard is also being amended under the R08-09 proposal. The limit will be revised on the Ship Canal to:

4.0 mg/L as a daily minimum averaged over 7 days

3.5 mg/L at any time.

The Agency's Statement of Reason identifies waterways that will not be able to meet the proposed D.O. standards, and the Ship Canal is not identified on this list, except generically, as all of the Chicago waterways have lower D.O. levels during wet weather periods attributed to combined sewer overflows.

R08-09 also includes revised water quality temperature limits, both period averages throughout the year and a daily maximum of 90.3 degrees F, which can be exceeded 2 percent of the year, with an absolute maximum of 93.9 degrees F. (See proposed Section 302.408.) Midwest Generation is the primary thermal load on the Ship Canal according to the Agency's Statement of Reason, and this rule change could result in one or more power plants closing, according to the Agency's Statement of Reason. Temperature is not part of Lemont Refinery's site-specific request for ammonia, but this rule may have future implications on the refinery's existing thermal load to the Ship Canal as part of future NPDES permits. During the winter months, the Refinery adds steam to the activated sludge process to maintain sufficient temperatures for nitrification.

4.2 USGS/IEPA Waterway Monitoring

The USGS previously maintained a water quality station (No. 05537000) near the Lockport Lock and Dam, 5.3 miles downstream from Lemont Refinery's outfall. During the last rule change for Lemont Refinery, water quality data were tabulated from 1978 through 1996. The data indicated the existing unionized ammonia standard had not been achieved only three times during that reporting period. In all three exceedances, total ammonia was less than or equal to 1.7 mg/L. The last time the 0.1 mg/L un-

un-ionized standard was exceeded was May 4, 1994 with an un-ionized ammonia concentration of 0.177 mg/L. No water quality data are available for the time period since 1996 for station 05537000, as this monitoring station was discontinued.

The USGS has also maintained a water quality station (No. 05536995) near Romeoville, 0.3 miles downstream from Lemont Refinery's outfall. As this station is closer to Lemont Refinery, it would be more responsive to changes in water quality associated with the effluent discharge. During the last rule change for Lemont Refinery, water quality data were tabulated from 1987 through 1991. The data indicated the un-ionized ammonia standard had not been achieved only one time (August 1987) during that reporting period. The single exceedance was caused by a high pH (8.78) since the ammonia concentration was only 1.1 mg/L. Un-ionized ammonia concentrations decreased through the end of the reporting period, consistently below 0.05 mg/L. More recent USGS ammonia water quality data at Romeoville are included in Appendix C, for the 1999 to 2001 time period. Ammonia levels have declined based upon a comparison of the 1994 to 1996 data to the 1999 to 2001 data.

D.O. data were available from March 1999 to February 2001 at station 05536995. (USGS data from March 1999 to February 2001 are presented in Appendix C.) In 24 sampling events during this time period, three events produced D.O. concentrations below 4.0 mg/L, with the minimum reported as 3.2 mg/L. These three samples were in July 1999 (two samples from this month) and June 2000. Other summer D.O. concentrations were above the existing 4.0 mg/L D.O. minimum water quality standard.

4.3 Metropolitan Water Reclamation District of Greater Chicago Waterways Data

Data for MWRDGC ammonia sampling (total and un-ionized) from January 2000 to July 2002 are presented in Tables 4-1 and 4-2. The data are from four sampling locations: Lockport Forebay on the Ship Canal, Jefferson Street on the Des Plaines River, Empress Casino on the Des Plaines River, and the I-55 Bridge on the Des Plaines River. This is the most current data available. Average total ammonia concentration declines from 0.65 mg/L on the Ship Canal to 0.34 mg/L at the I-55 Bridge on the Des Plaines River. Un-ionized ammonia concentration at all four locations consistently achieved the existing 0.1 mg/L standard throughout the data period. On the Ship Canal, the un-ionized ammonia averaged a low 0.005 mg/L from 2000 to 2002, with a maximum reported as 0.070 mg/L.

TABLE 4-1
CHICAGO SANITARY AND SHIP CANAL /
DES PLAINES RIVER
TOTAL AMMONIA, NH₃/N, mg/L

Date	Lockport Forebay	Jefferson Street	Empress Casino	I-55 Bridge
	Chicago S&S Canal	Des Plaines River	Des Plaines River	Des Plaines River
01/20/00		0.58	0.61	
01/27/00		0.43	0.44	
02/03/00		0.45	0.36	0.38
02/10/00		0.95	0.76	
02/17/00		0.61	0.63	
02/24/00		1.22	1.31	0.79
03/02/00		0.90	0.78	
03/09/00		0.89	0.72	
03/16/00		0.49	0.54	1.92
03/23/00		0.48	0.32	0.00
03/30/00		0.53	0.22	0.65
04/06/00		0.82	0.51	0.17
04/13/00		0.39	0.64	0.27
04/20/00		0.67	0.46	
04/27/00		0.29	0.15	0.15
05/04/00		0.24	0.21	1.38
05/11/00		0.85	0.64	0.19
05/18/00		0.46	0.29	0.16
05/25/00		0.23	0.24	0.69
06/01/00		0.26	0.32	0.25
06/08/00		0.22	0.19	0.22
06/15/00		0.29	0.23	0.31
06/22/00		0.33	0.18	0.17
06/29/00		0.24	0.20	0.23
07/06/00		0.22	0.20	0.27
07/13/00		0.25	0.18	0.21
07/20/00		0.23	0.18	0.21
07/27/00		0.25	0.22	0.16
08/03/00		0.49	0.17	0.14
08/10/00		0.25	0.20	0.63
08/17/00		0.24	0.14	0.21
08/24/00		0.24	0.20	0.16
08/31/00		0.20	0.17	0.13
09/07/00		0.22	0.15	0.22
09/14/00		0.43	0.34	

TABLE 4-1
CHICAGO SANITARY AND SHIP CANAL /
DES PLAINES RIVER
TOTAL AMMONIA, NH₃/N, mg/L

Date	Lockport Forebay Chicago S&S Canal	Jefferson Street Des Plaines River	Empress Casino Des Plaines River	I-55 Bridge Des Plaines River
09/21/00		0.29	0.22	0.12
09/28/00		0.21	0.21	0.13
10/05/00		0.21	0.18	0.33
10/12/00		0.26	0.31	0.18
10/19/00		0.19	0.19	0.20
10/26/00		0.26	0.21	0.35
11/02/00		0.25	0.28	0.14
11/08/00		0.20	0.17	0.18
11/16/00		0.12	0.19	
11/21/00		0.31	0.25	0.13
11/30/00		0.25	0.22	0.17
12/07/00		0.34	0.33	0.21
12/14/00		0.47	0.50	0.23
12/21/00		0.73	0.53	0.23
01/04/01	1.45	0.88	0.62	0.56
01/11/01	4.03	2.17	1.02	0.69
01/18/01	1.04	1.17	0.94	
01/25/01	0.95	0.78	0.68	0.73
02/01/01	1.22	1.72	0.97	0.76
02/08/01	0.95	0.72	0.77	0.78
02/15/01	0.48	0.39	0.36	0.38
02/22/01	0.81	0.48	0.57	
03/01/01	1.28	0.95	1.01	
03/08/01	1.01	0.98	0.77	0.59
03/15/01	1.32	0.81	0.73	1.04
03/22/01	1.18	1.13	0.76	0.60
03/29/01	0.61	0.47	0.43	0.29
04/05/01	2.59	1.11	0.55	0.81
04/12/01	0.81	0.65	0.84	
04/19/01	0.48	0.34	0.28	0.28
04/26/01	0.47	0.30	0.23	0.23
05/03/01	0.74	0.36	0.20	0.01
05/10/01	0.62	0.42	0.27	0.18
05/17/01	0.76	0.51	0.35	0.30
05/24/01	0.51	0.37	0.28	0.33

TABLE 4-1
 CHICAGO SANITARY AND SHIP CANAL /
 DES PLAINES RIVER
 TOTAL AMMONIA, NH3/N, mg/L

Date	Lockport Forebay Chicago S&S Canal	Jefferson Street Des Plaines River	Empress Casino Des Plaines River	I-55 Bridge Des Plaines River
05/31/01	0.49	0.35	0.23	0.18
06/07/01	0.42	0.31	0.33	
06/14/01	0.87	0.41	0.15	0.08
06/21/01	0.34	0.22	0.25	0.21
06/28/01	0.39	0.24	0.10	0.07
07/05/01	0.32	0.30	0.23	0.10
07/12/01	0.37	0.29	0.21	0.36
07/19/01	0.29	0.23	0.23	0.16
07/26/01	0.65	0.52	0.37	0.30
08/02/01	0.28	0.23	0.13	
08/09/01	0.29	0.26	0.18	
08/16/01	0.45	0.30	0.23	0.14
08/23/01	0.25	0.25	0.22	0.21
08/30/01	0.37	0.23	0.21	
09/06/01	0.01	0.19	0.17	0.08
09/13/01	0.28	0.23	0.15	
09/20/01	0.61	0.31	0.31	
09/27/01	0.37	0.30	0.20	
10/04/01	0.18	0.13	0.10	0.07
10/11/01	0.28	0.24	0.24	
10/15/01	0.42			
10/18/01	0.27	0.14	0.20	
10/25/01	0.20	0.28	0.24	
11/01/01	0.23	0.16	0.13	
11/08/01	0.33	0.30	0.19	
11/15/01	0.37	0.36	0.23	
11/19/01	0.42			
11/20/01	0.40	0.35	0.24	
11/29/01	0.33	0.34	0.21	
12/06/01	0.39	0.36	0.30	
12/13/01	0.48	0.36	0.23	
12/20/01	0.33	0.32	0.23	
12/27/01	0.24	0.28	0.27	
01/14/02	0.27			
01/22/02	0.61			

TABLE 4-1
 CHICAGO SANITARY AND SHIP CANAL /
 DES PLAINES RIVER
 TOTAL AMMONIA, NH₃/N, mg/L

Date	Lockport Forebay Chicago S&S Canal	Jefferson Street Des Plaines River	Empress Casino Des Plaines River	I-55 Bridge Des Plaines River
01/28/02	0.95			
02/04/02	0.77			
02/11/02	0.74			
02/19/02	0.47			
02/25/02	0.62			
03/04/02	0.58			
03/11/02	0.59			
03/18/02	0.87			
03/25/02	1.08			
04/01/02	0.79			
04/08/02	0.72			
04/15/02	0.58			
04/22/02	1.38			
04/29/02	0.62			
05/06/02	0.77			
05/13/02	0.49			
05/20/02	0.48			
05/28/02	0.55			
06/03/02	0.61			
06/10/02	0.31			
06/17/02	0.52			
06/24/02	0.32			
07/01/02	0.50			
07/08/02	0.42			
07/15/02	0.69			
07/22/02	0.70			
07/29/02	0.57			
AVERAGE	0.65	0.49	0.37	0.34
Maximum	4.03	2.17	1.02	1.92

R:\Citgo\Ammonia Site Specific\Ammonia Water Quality Data-Des Plaines River.xls\Ammonium-N

TABLE 4-2
CHICAGO SANITARY AND SHIP CANAL /
DES PLAINES RIVER
UN-IONIZED AMMONIA, mg/L

Date	Lockport Forebay Chicago S&S Canal	Jefferson Street Des Plaines River	Empress Casino Des Plaines River	I-55 Des Plaines River
01/20/00		0.013	0.029	
01/27/00		0.006	0.031	
02/03/00		0.013	0.012	0.015
02/10/00		0.007	0.014	
02/17/00		0.003	0.006	
02/24/00		0.007	0.009	0.097
03/02/00		0.010	0.013	
03/09/00		0.012	0.053	
03/16/00		0.005	0.010	0.014
03/23/00		0.003	0.005	0.032
03/30/00		0.005	0.008	0.025
04/06/00		0.004	0.000	0.007
04/13/00		0.001	0.001	0.015
04/20/00		0.012	0.004	
04/27/00		0.003	0.004	0.000
05/04/00		0.002	0.002	0.001
05/11/00		0.005	0.014	0.028
05/18/00		0.009	0.004	0.002
05/25/00		0.004	0.007	0.008
06/01/00		0.007	0.004	0.009
06/15/00		0.002	0.002	0.002
06/22/00		0.004	0.001	0.005
06/29/00		0.003	0.004	0.008
07/06/00		0.001	0.004	0.006
07/13/00		0.001	0.001	0.001
07/20/00		0.004	0.002	0.005
07/27/00		0.004	0.005	0.011
08/03/00		0.007	0.003	0.004
08/10/00		0.016	0.021	0.000
08/17/00		0.003	0.000	0.005
08/24/00		0.007	0.001	0.002
08/31/00		0.003	0.006	0.004
09/07/00		0.004	0.005	0.005
09/14/00		0.012	0.010	0.007
09/21/00		0.004	0.004	

TABLE 4-2
 CHICAGO SANITARY AND SHIP CANAL /
 DES PLAINES RIVER
 UN-IONIZED AMMONIA, mg/L

Date	Lockport Forebay Chicago S&S Canal	Jefferson Street Des Plaines River	Empress Casino Des Plaines River	I-55 Des Plaines River
09/28/00		0.007	0.009	0.001
10/05/00		0.003	0.003	0.003
10/12/00		0.001	0.001	0.031
10/19/00		0.003	0.003	0.001
10/26/00		0.005	0.005	0.002
11/02/00		0.001	0.001	0.001
11/08/00		0.001	0.002	0.000
11/16/00		0.000	0.000	0.000
11/21/00		0.000	0.000	
11/30/00		0.000	0.002	0.002
12/07/00		0.000	0.000	0.000
12/14/00		0.006	0.009	0.009
01/04/01	0.002	0.000	0.000	
01/11/01	0.003	0.003	0.000	0.000
01/18/01	0.017	0.018	0.012	
01/25/01	0.000	0.000	0.001	0.000
02/01/01	0.001	0.001	0.001	0.000
02/08/01	0.000	0.000	0.000	0.000
02/15/01	0.001	0.000	0.000	0.001
02/22/01	0.000	0.000	0.002	
03/01/01	0.003	0.001	0.002	
03/08/01				0.010
03/15/01				0.026
03/22/01	0.003	0.002	0.002	0.004
03/29/01	0.001	0.001	0.001	0.001
04/05/01	0.007	0.003	0.001	0.001
04/12/01	0.003	0.002	0.002	
04/19/01	0.005	0.005	0.005	0.002
04/26/01	0.039	0.010	0.024	0.001
05/03/01	0.003	0.001	0.004	0.000
05/10/01	0.006	0.006	0.005	0.004
05/17/01	0.004	0.004	0.004	0.004
05/24/01	0.003	0.005	0.002	0.036
05/31/01	0.003	0.002	0.002	0.001
06/07/01	0.001	0.001	0.001	

TABLE 4-2
 CHICAGO SANITARY AND SHIP CANAL /
 DES PLAINES RIVER
 UN-IONIZED AMMONIA, mg/L

Date	Lockport Forebay Chicago S&S Canal	Jefferson Street Des Plaines River	Empress Casino Des Plaines River	I-55 Des Plaines River
06/14/01	0.015	0.007	0.002	0.000
06/21/01	0.004	0.003	0.003	
06/28/01	0.006	0.005	0.004	0.003
07/05/01	0.002	0.005	0.006	0.000
07/12/01	0.005	0.008	0.008	0.002
07/19/01	0.008	0.007	0.007	0.001
07/26/01	0.004	0.002	0.002	0.009
08/02/01	0.005	0.003	0.002	
08/09/01	0.001	0.001	0.001	
08/16/01	0.005	0.002	0.000	0.001
08/23/01	0.002	0.002	0.001	0.002
08/30/01	0.003	0.003	0.004	
09/06/01	0.000	0.002	0.002	0.001
09/13/01	0.003	0.006	0.002	
09/20/01	0.003	0.001	0.002	
09/27/01	0.002	0.001	0.000	
10/04/01	0.001	0.000	0.000	0.000
10/11/01	0.008	0.007	0.007	
10/15/01	0.001			
10/18/01	0.001	0.001	0.000	
10/25/01	0.002	0.001	0.001	
11/01/01	0.003	0.002	0.003	
11/08/01	0.001	0.001	0.000	
11/15/01	0.004	0.003	0.005	
11/19/01	0.002			
11/20/01	0.002	0.001	0.001	
11/29/01	0.002	0.002	0.001	
12/06/01	0.008	0.007	0.020	
12/13/01	0.003	0.007	0.010	
12/20/01	0.000	0.000	0.000	
12/27/01	0.001	0.001	0.001	
01/14/02	0.001			
01/22/02	0.006			
01/28/02	0.003			
02/04/02	0.006			

TABLE 4-2
 CHICAGO SANITARY AND SHIP CANAL /
 DES PLAINES RIVER
 UN-IONIZED AMMONIA, mg/L

Date	Lockport Forebay Chicago S&S Canal	Jefferson Street Des Plaines River	Empress Casino Des Plaines River	I-55 Des Plaines River
02/11/02	0.002			
02/19/02	0.006			
02/25/02	0.001			
03/04/02	0.006			
03/11/02	0.005			
03/18/02	0.005			
03/25/02	0.007			
04/01/02	0.022			
04/08/02	0.003			
04/15/02	0.004			
04/22/02	0.003			
04/29/02	0.001			
05/06/02	0.004			
05/13/02	0.004			
05/20/02	0.004			
05/28/02	0.001			
06/03/02	0.008			
06/10/02	0.002			
06/17/02	0.002			
06/24/02	0.004			
07/01/02	0.070			
07/08/02	0.006			
07/15/02	0.007			
07/22/02	0.019			
07/29/02	0.010			
Average	0.005	0.003	0.003	0.007
Maximum	0.070	0.018	0.024	0.097

R:\Citgo\Ammonia Site Specific\Ammonia Water Quality Data-Des Plaines River.xls\Ammonia-N

The MWRDGC also monitored D.O. at the I-55 Bridge during 2001. Table 4-3 presents the MWRDGC data. The minimum D.O. reported was 5.8 mg/L recorded in August 2001.

The MWRDGC collected D.O. readings hourly on the Ship Canal at Route 83, upstream of the refinery, and at the Lockport Powerhouse, downstream of the Lemont Refinery, from January 2002 to December 2006. Appendix C presents the data both graphically and in a tabular format, by year. Graphically, the Route 83 and Lockport Powerhouse D.O. values show similar trends, with the majority of the results below 4.0 mg/L in the months between April and October/November for all five years. Overall, minimum values were lower at Route 83, upstream of the Refinery. These data indicate the Refinery's incremental ammonia loading does not have an adverse impact on the D.O. concentration in the Ship Canal.

Further, hourly D.O. readings were collected on the Des Plaines River at Jefferson Street, downstream of the convergence of the Ship Canal with the Des Plaines River, from 2002 to 2006. These data are also presented in Appendix C. The graphs presenting these data show the majority of results below 4.0 mg/L occur in the months between May/June and August/September. Overall, during this data period, minimum values at Jefferson Street are higher than those on the Ship Canal and achieve 4.0 mg/L more consistently. These data indicate the Lemont Refinery's incremental ammonia discharged does not have an adverse impact on the D.O. concentration in the Des Plaines River.

4.4 Midwest Generation Data

Midwest Generation EME, LLC monitors D.O. on the Lower Des Plaines River at the I-55 Bridge from May to September. Hourly data were obtained from 2004, 2005, and 2006. Table 4-4 presents the minimum value for each month (May through September) by year. Only one month, June 2005, returned a result lower than 4.0 mg/L. The minimum value for this month was 2.8 mg/L.

TABLE 4-3
 METROPOLITAN WATER RECLAMATION DISTRICT OF GREATER CHICAGO
 DESPLAINES RIVER DATA FOR 2000 FROM LOCKPORT TO I-55

Date	Location	Parameter	Measured Value	Unit
02/03/00	95.0 I-55, Des Plaines River	DO	11.3	mg/L
02/17/00	95.0 I-55, Des Plaines River	DO	9.3	mg/L
02/24/00	95.0 I-55, Des Plaines River	DO	9.1	mg/L
03/02/00	95.0 I-55, Des Plaines River	DO	9.4	mg/L
03/16/00	95.0 I-55, Des Plaines River	DO	9.3	mg/L
03/23/00	95.0 I-55, Des Plaines River	DO	9.8	mg/L
03/30/00	95.0 I-55, Des Plaines River	DO	9.4	mg/L
04/06/00	95.0 I-55, Des Plaines River	DO	8.8	mg/L
04/13/00	95.0 I-55, Des Plaines River	DO	8.4	mg/L
04/27/00	95.0 I-55, Des Plaines River	DO	9.3	mg/L
05/04/00	95.0 I-55, Des Plaines River	DO	7.4	mg/L
05/11/00	95.0 I-55, Des Plaines River	DO	7.8	mg/L
05/18/00	95.0 I-55, Des Plaines River	DO	6.9	mg/L
05/25/00	95.0 I-55, Des Plaines River	DO	7.5	mg/L
06/01/00	95.0 I-55, Des Plaines River	DO	7.0	mg/L
06/08/00	95.0 I-55, Des Plaines River	DO	7.6	mg/L
06/15/00	95.0 I-55, Des Plaines River	DO	6.1	mg/L
06/22/00	95.0 I-55, Des Plaines River	DO	7.2	mg/L
06/29/00	95.0 I-55, Des Plaines River	DO	6.8	mg/L
07/06/00	95.0 I-55, Des Plaines River	DO	6.5	mg/L
07/13/00	95.0 I-55, Des Plaines River	DO	6.6	mg/L
07/20/00	95.0 I-55, Des Plaines River	DO	6.7	mg/L
07/27/00	95.0 I-55, Des Plaines River	DO	6.3	mg/L
08/03/00	95.0 I-55, Des Plaines River	DO	6.2	mg/L
08/10/00	95.0 I-55, Des Plaines River	DO	5.8	mg/L
08/17/00	95.0 I-55, Des Plaines River	DO	6.9	mg/L
08/24/00	95.0 I-55, Des Plaines River	DO	7.1	mg/L
08/31/00	95.0 I-55, Des Plaines River	DO	6.1	mg/L
09/07/00	95.0 I-55, Des Plaines River	DO	6.9	mg/L
09/14/00	95.0 I-55, Des Plaines River	DO	6.4	mg/L
09/28/00	95.0 I-55, Des Plaines River	DO	7.9	mg/L
10/05/00	95.0 I-55, Des Plaines River	DO	7.6	mg/L
10/12/00	95.0 I-55, Des Plaines River	DO	8.4	mg/L
10/19/00	95.0 I-55, Des Plaines River	DO	6.4	mg/L
10/26/00	95.0 I-55, Des Plaines River	DO	7.1	mg/L
11/02/00	95.0 I-55, Des Plaines River	DO	6.7	mg/L
11/08/00	95.0 I-55, Des Plaines River	DO	8.3	mg/L
11/16/00	95.0 I-55, Des Plaines River	DO	10.9	mg/L
11/30/00	95.0 I-55, Des Plaines River	DO	9.4	mg/L
12/07/00	95.0 I-55, Des Plaines River	DO	9.9	mg/L
12/14/00	95.0 I-55, Des Plaines River	DO	10.4	mg/L
Minimum		DO	5.8	mg/L

TABLE 4-4
MIDWEST GENERATION EME, LLC
LOWER DES PLAINES RIVER AT I-55 BRIDGE
MONTHLY MINIMUM
DISSOLVED OXYGEN CONCENTRATION, mg/L

Month ^{a/}	2004	2005	2006
May	6.0	5.7	4.5
June	5.3	2.8	4.2
July	4.8	4.7	4.6
August	5.1	4.6	4.7
September	5.3	5.6	5.9

a/ Dissolved oxygen data collected May through September each year. Value reported is the minimum hourly mean dissolved oxygen concentration for the given month.

R:\Citgo\Ammonia Site Specific\[MidwestGenDO.xls]DO

4.5 IEPA Waterway Classification/Assessment

The Ship Canal is part of the Des Plaines/Lake Michigan River Basin. The Chicago River flows into the Ship Canal. The Calumet River system flows into the Calumet-Sag Channel, which flows into the Ship Canal near Lemont, Illinois. The Ship Canal, a tributary to the Des Plaines River, flows into the river just north of the City of Joliet.

Stream quality is characterized by physical attributes and stream use. The IEPA assesses Illinois water bodies for the degree of overall and individual use support (IEPA, 2006). These individual uses include fish consumption and aquatic life, which apply to all water bodies within the State. Other uses include swimming, secondary contact, drinking, and industrial water supplies whose uses apply to defined water body segments. The degree of designated use support is described in relation to full support of the use: full/threatened support, partial support, and non-support.

The aquatic habitat on the portion of the Ship Canal where the Lemont Refinery is located was rated as “poor to very poor” (IEPA, 2006). Overall stream use is designated as non-support for fish consumption and aquatic life. The identified causes of impairment were polychlorinated biphenyls (PCBs), iron, oil and grease, D.O., total nitrogen, and total phosphorus. Sources included combined sewer overflows, urban runoff/storm sewers, impacts from hydrostructure flow regulation/modification, municipal point source discharges, and other unknown sources.

Two Use Attainability Analyses (UAA), one on the lower Des Plaines River and one on the Chicago Area Waterways, have been completed, and these reports serve as part of the technical basis behind the recent proposed rule change submitted by the Agency in R08-09. The UAA for the Chicago Area Waterways focused on the potential uses of these waterways. The refinery’s request for a site-specific ammonia limit is not impacted by the UAA, nor will it have any impact on the Agency’s proposal in R08-09.^{2/} The available water quality data on the Ship Canal indicate that the proposed more restrictive un-ionized ammonia water quality standard is currently being achieved.

^{2/} CITGO also has a variance on TDS. If R08-09 is adopted as proposed, the TDS water quality standard will be eliminated. A sulfate limit will be adopted under the Agency’s proposal, that the Ship Canal will achieve downstream of the Refinery outfall.

5. DERIVATION OF EFFLUENT LIMITS

Since 1988, Lemont Refinery has been granted three site-specific rule changes for ammonia effluent limitations. The first limits were derived using the U. S. EPA BAT effluent guidelines. The subsequent limitations were based upon effluent quality, as that condition had become more restrictive. The existing limitations are as follows:

Parameter	Concentration Limits, mg/L
Monthly Average	9.4
Daily Maximum	26.0

These limits were incorporated into the refinery's NPDES permit (IL0001989). The provisions granting the site-specific ammonia limits terminate December 31, 2008.

Lemont Refinery has consistently achieved the BAT limitations. However, despite capital expenditure for improving the wastewater treatment facilities, Lemont Refinery has not continuously achieved the 3.0 mg/L monthly average or 6.0 mg/L daily maximum limits at 35 IAC 304.122. Therefore, alternative ammonia effluent limits have been derived, using existing ammonia effluent data.

The U. S. EPA *Technical Support Document* for Water Quality Based Toxics Control was used to calculate proposed effluent limits based on ammonia effluent data from June 2002 through May 2007. This approach to deriving ammonia effluent limits is based upon the performance of the treatment facility, and the time period listed is representative of the current performance of the treatment facility. The limits for monthly and daily effluent concentrations are based on a statistical analysis using the 95th percentile values of the ammonia distribution. The methodology uses a multiplying factor based upon the coefficient of variation and number of data points.

Calculations for this statistical analysis are presented in Appendix D.

Over the last several years, the Lemont Refinery has been processing heavier crudes and expects this source to continue to expand. As the Lemont Refinery and the industry have learned over the past several years, wastewater treatment, including the ability to consistently nitrify, has increased in difficulty with the processing of the heavier crudes.

Using the 95th percentile, the resultant monthly ammonia effluent limit is as follows:

06/2002 to 05/2007 Existing Effluent Quality-based Limits	
Monthly Effluent Limit	6.9 mg/L

Using the 95th percentile, the resultant daily maximum ammonia effluent limit is as follows:

06/2002 to 05/2007 Existing Effluent Quality-based Limits	
Daily Maximum Limit	10.6 mg/L

The 95th percentile limit for daily maximum is a significant reduction from the current effluent limit that the Lemont Refinery is currently permitted to discharge (26.0 mg/L). The 6.9 mg/L monthly average limit is also more restrictive than the current 9.4 mg/L limit. The proposed limits represent continued emphasis on improvement in wastewater controls and achieving nitrification in the wastewater treatment facility. To control upsets, the Lemont Refinery has the ability to hold water in its Treated Water Basin, and recycle this water if necessary. This flexibility would allow the refinery to discharge less than 200 pounds per day (and 100 pounds per day on a monthly average) during upset periods that exceed the 10.6 mg/L daily maximum limit. Therefore, the relief requested to apply the 6.9 mg/L limit only when the discharge is more than 100 pounds per day on a monthly average and the 10.6 mg/L would apply only when the daily discharge is more than 200 pounds per day.

The impact of the proposed limits on the Ship Canal is less than the impact from the previous relief granted to the Lemont Refinery. A 1992 study by Huff & Huff, Inc. measured both the Zone of Initial Dilution (ZID) and mixing zone. At that time the 7-day, 10-year low flow was 1,100 MGD, due to the

due to the discretionary diversion from Lake Michigan. The Lemont Refinery Outfall 001 is through a submerged 15-inch diameter pipe, discharging in the downward direction 15 feet below the low flow Ship Canal elevation. There is entrained air in the effluent due to a weir upstream. The plume is strongly buoyant due to the air as well as temperature differences between the Outfall and the Ship Canal. Huff & Huff found the mixing to be rapid, with a ZID occupying a very small 100 sq ft and providing a 10:1 dilution. In 1992, the mixing zone was measured as occupying on 0.05 acres and providing a 40:1 dilution at the point it extended 25 percent of the stream width at the surface. The design average flow of the Lemont Refinery today has not changed since the mixing zone study, so that study remains valid today. However, the reduction in discretion diversion from Lake Michigan has reduced the 7-day, 10-year low flow from 1,100 MGD in 1992 to 850 MGD. This results in the maximum upstream flow available of 25 percent of 850 MGD, or 212.5 MGD. Compared to the design average flow of 5.79 MGD, this yields an available mixing zone of 36.7:1. Therefore, for predicting the concentration at the edge of the mixing zone, the 36.7:1 will be used going forward.

The average ammonia in the Ship Canal over the most recent five years in the refinery's water intake has averaged 0.634 mg/L. Using the proposed ammonia monthly limit of 6.9 mg/L, the following ammonia concentrations are predicted:

Upstream	0.634 mg/L
Edge of ZID	1.89 mg/L
Edge of Mixing Zone	0.805 mg/L
Ship Canal after Complete Mixing	0.676 mg/L

The percent change in the total ammonia water quality, 6.6 percent at the monthly average limit and the 7-day, 10-year low flow, will contribute to the un-ionized ammonia by a similar percentage immediately downstream. From Table 4.2, the maximum un-ionized reported at Lockport from 2000 to 2002 was 0.070 mg/L, which includes Citgo's contribution already. Both the total and un-ionized ammonia will decline downstream, as the monthly average limit is being reduced by 27 percent over the current monthly limit. Ammonia water quality violations are not now occurring in the receiving stream, and the proposed limits presented above will further reduce the ammonia loading. Therefore, no water quality violations will be associated with this request.

6. SUMMARY

The Lemont Refinery is seeking a renewal of its effluent ammonia site-specific limits for an additional ten years. Over the past decade, progress has been made in the refinery's ability to nitrify; however, recently this success has been challenged by the introduction of heavier crudes as feedstock. This source of crude oil has placed additional loadings on the wastewater treatment system that the refinery is learning to handle.

The Agency has proposed amending the ammonia (and TDS and sulfate) water quality standards that apply to the Chicago Sanitary & Ship Canal, based upon an extensive Use Attainability Analysis. The data presented herein indicate that the requested relief by the Lemont Refinery will not impede the ability of the Ship Canal to achieve the proposed ammonia water quality limit (or the TDS/sulfate changes).

Based upon U.S. EPA protocol, revised daily maximum and monthly average ammonia effluent limits have been derived based upon the recent performance of the wastewater treatment plant operation. The monthly limit calculated, based on the U.S. EPA *Technical Support Document* is 6.9 mg/L, a reduction of 27 percent in the current adjusted standard. This requested limit is based on the 95th percentile monthly limit and would apply whenever the monthly average discharge exceeds 100 pounds per day.

For the daily maximum, a limit of 10.6 mg/L is requested, based on the 95th percentile of the last five years. This is a 59 percent reduction from the current adjusted standard, and would apply whenever the daily discharge exceeds 200 pounds per day ammonia.

APPENDIX A

NPDES GENERAL PERMIT NO. IL0001589

Processed by:
BMP/REQ/CWH
Original copy filed



ILLINOIS ENVIRONMENTAL PROTECTION AGENCY

1021 NORTH GRAND AVENUE EAST, P.O. BOX 19276, SPRINGFIELD, ILLINOIS 62794-9276 - (217) 782-3397

JAMES R. THOMPSON CENTER, 100 WEST RANDOLPH, SUITE 11-300, CHICAGO, IL 60601 - (312) 814-6026

217/782-0610

ROD R. BLAGOJEVICH, GOVERNOR

DOUGLAS P. SCOTT, DIRECTOR

JUN 22 2007

CITGO Petroleum Corporation
135th and New Avenue
Lemont, Illinois 60439

Re: CITGO Petroleum Corporation
CITGO Petroleum Corporation - Lemont Refinery
NPDES Permit No. IL0001589
Modification of NPDES Permit (After Public Notice)

Gentlemen:

The Illinois Environmental Protection Agency has reviewed the request for modification of the above-referenced NPDES Permit and issued a public notice based on that request. The final decision of the Agency is to modify the Permit as follows:

Internal outfall A01 has been added for the discharge of scrubber wastewater. This outfall will be regulated for temperature and hexavalent chromium. Outfall A01 will be subject to the general use temperature limitations, while outfall 001 will be regulated by the secondary contact temperature limitations. Special Conditions 17 and 19 have been changed and Special Condition 20 has been added.

Enclosed is a copy of the modified Permit. You have the right to appeal this modification to the Illinois Pollution Control Board within a 35 day period following the modification date shown on the first page of the permit.

Should you have any question or comments regarding the above, please contact Darin LeCrone of my staff.

Sincerely,

Alan Keller, P.E.
Manager, Permit Section
Division of Water Pollution Control

SAK:DEL:05121401.bah

Attachment: Modified Permit

cc: Records Unit
Compliance Assurance Section
Des Plaines Region
NIPC
US EPA

RECEIVED

JUN 25 2007

NPDES Permit No. IL0001589

Illinois Environmental Protection Agency

Division of Water Pollution Control

1021 North Grand Avenue East

Post Office Box 19276

Springfield, Illinois 62794-9276

NATIONAL POLLUTANT DISCHARGE ELIMINATION SYSTEM

Modified (NPDES) Permit

Expiration Date: July 31, 2011

Issue Date: July 28, 2006

Effective Date: August 1, 2006

Modification Date: June 22, 2007

Name and Address of Permittee:

CITGO Petroleum Corporation
135th and New Avenue
Lemont, Illinois 60439

Facility Name and Address:

CITGO Petroleum Corporation - Lemont Refinery
135th and New Avenue
Lemont, Illinois 60439
(Will County)

Discharge Number and Name:

001 Treated Refinery Wastewater
A01 FCCU Wet Gas Scrubber Wastewater
002 Stormwater Basin Overflow
003 Stormwater
004 Stormwater
005 Stormwater
006 Stormwater
007 Intake Screen Backwash
008 Stormwater

Receiving Waters:

Chicago Sanitary and Ship Canal
Illinois and Michigan Canal
Illinois and Michigan Canal
Illinois and Michigan Canal
Illinois and Michigan Canal
Illinois and Michigan Canal
Chicago Sanitary and Ship Canal
Illinois and Michigan Canal

In compliance with the provisions of the Illinois Environmental Protection Act, Title 35 of Ill. Adm. Code, Subtitle C and/or Subtitle D, Chapter 1, and the Clean Water Act (CWA), the above-named permittee is hereby authorized to discharge at the above location to the above-named receiving stream in accordance with the standard conditions and attachments herein.

Permittee is not authorized to discharge after the above expiration date. In order to receive authorization to discharge beyond the expiration date, the permittee shall submit the proper application as required by the Illinois Environmental Protection Agency (IEPA) not later than 180 days prior to the expiration date.



Alan Keller, P.E.
Manager, Permit Section
Division of Water Pollution Control

SAK:DEL:05121401.bah

NPDES Permit No. IL0001589

Effluent Limitations and Monitoring

1. From the modification date of this permit until the expiration date, the effluent of the following discharge(s) shall be monitored and limited at all times as follows:

Outfall(s): 001 - Treated Refinery Wastewater: 5.79 MGD DAF

PARAMETER	LOAD LIMITS lbs/day DAF (DMF)		CONCENTRATION LIMITS mg/l		SAMPLE FREQUENCY	SAMPLE TYPE
	30 DAY AVERAGE	DAILY MAXIMUM	30 DAY AVERAGE	DAILY MAXIMUM		
Contributory Waste Streams:						
1) Process Wastewater			5) Hydrostatic Test Water			
2) Cooling Tower Blowdown			6) Chemical Cleaning			
3) Non-Process Wastewater, Stormwater, Utility Water, Boiler Blowdown			7) Seneca, Chicago Carbon, BOC Process Water			
4) Sanitary Waste Water			8) Scrubber Wastewater			
Flow (MGD)	See Special Condition 1				Daily	Continuous
pH	See Special Condition 2				2/Week	Grab
BOD ₅	1008.80	2472.32			2/Week	Composite
CBOD ₅			20	40	2/Week	Composite
Oil and Grease	536.40	1005.75	15	20	2/Week	Mathematical Composite
Total Suspended Solids	1475.10	2313.23	25	50	2/Week	Composite
Phenols	10.28	42.37	0.3	0.4	2/Week	Composite
Ammonia as N	1005.75	2212.65	9.4	26.0	2/Week	Composite
COD	12873.60	24808.50			2/Week	Composite
Chromium (Total)	11.99	34.51		1.0	2/Week	Composite
Chromium (Hexavalent)*	0.99	2.20	0.1	0.3	1/Month	Grab
Sulfide	9.72	21.79			2/Week	Composite
Cyanide	5.04	14.41	0.1	0.2	2/Week	Composite
Fluoride	756.60	2161.70	15	28.8	2/Week	Composite
Sulfate				Monitor Only	2/Week	Composite
Total Dissolved Solids				Monitor Only	2/Week	Composite
Temperature	See Special Condition 17				Continuous	Measure
Total Residual Chlorine	See Special Condition 19			0.05	1/Day	Grab

* See Special Condition 20

NPDES Permit No. IL0001589

Effluent Limitations and Monitoring

1. From the modification date of this permit until the expiration date, the effluent of the following discharge(s) shall be monitored and limited at all times as follows:

Outfall(s): A01 - FCCU Wet Gas Scrubber Wastewater: 0.375 MGD

PARAMETER	LOAD LIMITS lbs/day		CONCENTRATION		SAMPLE FREQUENCY	SAMPLE TYPE
	30 DAY AVERAGE	DAILY MAXIMUM	30 DAY AVERAGE	DAILY MAXIMUM		
Flow (MGD)					Estimate When Monitoring	
Temperature*					Continuous	Measure
Chromium (Hexavalent)**			0.1	0.3	1/Month	Grab

*See Special Condition 17

** See Special Condition 20

NPDES Permit No. IL0001589

Effluent Limitations and Monitoring

1. From the modification date of this permit until the expiration date, the effluent of the following discharge(s) shall be monitored and limited at all times as follows:

Outfall(s): 002 - Stormwater Basin Overflow: Intermittent

PARAMETER	LOAD LIMITS lbs/day		CONCENTRATION		SAMPLE FREQUENCY	SAMPLE TYPE
	30 DAY AVERAGE	DAILY MAXIMUM	30 DAY AVERAGE	DAILY MAXIMUM		
Contributory Waste Streams:						
1) Refinery Stormwater		7) Biomass				
2) Treated Process Water (Fire Water)		8) Off Site Stormwater Runoff				
3) Utility Water		9) Exxon Mobil Terminal Stormwater				
4) Boiler Blowdown		10) Chicago Carbon Stormwater				
5) Tank Farm Stormwater		11) Kinder Morgan Stormwater				
6) Hydrostatic Test Water		12) BOC Stormwater				
		13) Seneca Stormwater				
Flow (MGD)	See Special Condition 1				Estimate When Monitoring	
pH	See Special Condition 2				1/Day	Grab
BOD ₅			20	40	1/Day	Grab
Total Suspended Solids			25	50	1/Day	Grab
Oil and Grease			15	30	1/Day	Grab
Phenols			0.3	0.6	1/Day	Grab
Chromium (Total)				1.0	1/Day	Grab
Chromium (Hexavalent)			0.1	0.3	1/Day	Grab
Cyanide			0.1	0.2	1/Day	Grab
Fluoride			15	28.6	1/Day	Grab
Ammonia as N			9.4	26.0	1/Day	Grab
COD				Monitor	1/Day	Grab
Sulfide				Monitor	1/Day	Grab

NPDES Permit No. IL0001589

Effluent Limitations and Monitoring

1: From the modification date of this permit until the expiration date, the effluent of the following discharge(s) shall be monitored and limited at all times as follows:

Outfall(s): 007 - Intake Screen Backwash: 0.027 MGD DAF

PARAMETER	LOAD LIMITS lbs/day DAF (DMF)		CONCENTRATION LIMITS mg/l		SAMPLE FREQUENCY	SAMPLE TYPE
	30 DAY AVERAGE	DAILY MAXIMUM	30 DAY AVERAGE	DAILY MAXIMUM		
Flow (MGD)	See Special Condition 1				1/Week	Estimate
Total Residual Chlorine				0.05	1/Week*	Grab

*Sample frequency shall be 1/Week when chlorinating.

Outfalls: 003, 004, 005, 006, and 008 - Stormwater Runoff: Intermittent

See Special Condition 10

NPDES Permit No. IL0001589

Special Conditions

SPECIAL CONDITION 1. Flow (in Million Gallons per Day) shall be reported as a monthly average and a daily maximum on the DMR form.

SPECIAL CONDITION 2. The pH shall be in the range 6.0 to 9.0. The monthly minimum and monthly maximum values shall be reported on the DMR form.

SPECIAL CONDITION 3. Samples taken in compliance with the effluent monitoring requirements shall be taken at a point representative of the discharge, but prior to entry into the receiving stream.

SPECIAL CONDITION 4. If an applicable effluent standard or limitation is promulgated under Sections 301(b)(2)(C) and (D), 304(b)(2), and 307(a)(2) of the Clean Water Act and that effluent standard or limitation is more stringent than any effluent limitation in the permit or controls a pollutant not limited in the NPDES Permit, the Agency shall revise or modify the permit in accordance with the more stringent standard or prohibition and shall so notify the permittee.

SPECIAL CONDITION 5. This permit may be modified to include different final effluent limitations or requirements which are consistent with applicable laws, regulations, or judicial orders. The Agency will public notice the permit modification.

SPECIAL CONDITION 6. Mathematical composites for oil, fats and greases shall consist of a series of grab samples collected over any 24-hour consecutive period. Each sample shall be analyzed separately and the arithmetic mean of all grab samples collected during a 24-hour period shall constitute a mathematical composite. No single grab sample shall exceed a concentration of 75 mg/l.

SPECIAL CONDITION 7. For the purpose of this permit discharges from outfalls 003, 004, 005, 006, and 008 are limited to stormwater, free from process and other wastewater discharges.

SPECIAL CONDITION 8. Stormwater discharges identified as outfalls 003, 004, 005, 006, and 008 may be rerouted to the facility's WWTP and discharged via outfall 001, subject to the limitations of this permit. If these stormwater discharges are routed to the WWTP then they shall no longer be subject to the requirements of Special Condition 10, but instead shall meet the requirements of Special Condition 9.

SPECIAL CONDITION 9. (Outfalls 001 and 002) The Agency has determined that the effluent limitations in this permit constitute BAT/BCT for storm water which is treated in the existing treatment facilities for purposes of this permit reissuance, and no pollution prevention plan will be required for such storm water. In addition to the chemical specific monitoring required elsewhere in this permit, the permittee shall conduct an annual inspection of the facility site to identify areas contributing to a storm water discharge associated with industrial activity, and determine whether any facility modifications have occurred which result in previously-treated storm water discharges no longer receiving treatment. If any such discharges are identified the permittee shall request a modification of this permit within 30 days after the inspection. Records of the annual inspection shall be retained by the permittee for the term of this permit and be made available to the Agency on request.

SPECIAL CONDITION 10.

STORM WATER POLLUTION PREVENTION PLAN (SWPPP)

- A. A storm water pollution prevention plan shall be developed by the permittee for the storm water associated with industrial activity at this facility. The plan shall identify potential sources of pollution which may be expected to affect the quality of storm water discharges associated with the industrial activity at the facility. In addition, the plan shall describe and ensure the implementation of practices which are to be used to reduce the pollutants in storm water discharges associated with industrial activity at the facility and to assure compliance with the terms and conditions of this permit.
- B. The plan shall be completed within 180 days of the effective date of this permit. Plans shall provide for compliance with the terms of the plan within 365 days of the effective date of this permit. The owner or operator of the facility shall make a copy of the plan available to the Agency at any reasonable time upon request. [Note: If the plan has already been developed and implemented it shall be maintained in accordance with all requirements of this special condition.]
- C. The permittee may be notified by the Agency at any time that the plan does not meet the requirements of this condition. After such notification, the permittee shall make changes to the plan and shall submit a written certification that the requested changes have been made. Unless otherwise provided, the permittee shall have 30 days after such notification to make the changes.

NPDES Permit No. IL0001589

Special Conditions

- D. The discharger shall amend the plan whenever there is a change in construction, operation, or maintenance which may affect the discharge of significant quantities of pollutants to the waters of the State or if a facility inspection required by paragraph G of this condition indicates that an amendment is needed. The plan should also be amended if the discharger is in violation of any conditions of this permit, or has not achieved the general objective of controlling pollutants in storm water discharges. Amendments to the plan shall be made within the shortest reasonable period of time, and shall be provided to the Agency for review upon request.
- E. The plan shall provide a description of potential sources which may be expected to add significant quantities of pollutants to storm water discharges, or which may result in non-storm water discharges from storm water outfalls at the facility. The plan shall include, at a minimum, the following items:
1. A topographic map extending one-quarter mile beyond the property boundaries of the facility, showing: the facility, surface water bodies, wells (including injection wells), seepage pits, infiltration ponds, and the discharge points where the facility's storm water discharges to a municipal storm drain system or other water body. The requirements of this paragraph may be included on the site map if appropriate.
 2. A site map showing:
 - I. The storm water conveyance and discharge structures;
 - ii. An outline of the storm water drainage areas for each storm water discharge point;
 - iii. Paved areas and buildings;
 - iv. Areas used for outdoor manufacturing, storage, or disposal of significant materials, including activities that generate significant quantities of dust or particulates.
 - V. Location of existing storm water structural control measures (dikes, coverings, detention facilities, etc.);
 - vi. Surface water locations and/or municipal storm drain locations
 - vii. Areas of existing and potential soil erosion;
 - viii. Vehicle service areas;
 - ix. Material loading, unloading, and access areas.
 3. A narrative description of the following:
 - i. The nature of the industrial activities conducted at the site, including a description of significant materials that are treated, stored or disposed of in a manner to allow exposure to storm water;
 - ii. Materials, equipment, and vehicle management practices employed to minimize contact of significant materials with storm water discharges;
 - iii. Existing structural and non-structural control measures to reduce pollutants in storm water discharges;
 - iv. Industrial storm water discharge treatment facilities;
 - V. Methods of onsite storage and disposal of significant materials;
 4. A list of the types of pollutants that have a reasonable potential to be present in storm water discharges in significant quantities.
 5. An estimate of the size of the facility in acres or square feet, and the percent of the facility that has impervious areas such as pavement or buildings.

NPDES Permit No. IL0001589

Special Conditions

6. A summary of existing sampling data describing pollutants in storm water discharges.
- F. The plan shall describe the storm water management controls which will be implemented by the facility. The appropriate controls shall reflect identified existing and potential sources of pollutants at the facility. The description of the storm water management controls shall include:
 1. Storm Water Pollution Prevention Personnel - Identification by job titles of the individuals who are responsible for developing, implementing, and revising the plan.
 2. Preventive Maintenance - Procedures for inspection and maintenance of storm water conveyance system devices such as oil/water separators, catch basins, etc., and inspection and testing of plant equipment and systems that could fail and result in discharges of pollutants to storm water.
 3. Good Housekeeping - Good housekeeping requires the maintenance of clean, orderly facility areas that discharge storm water. Material handling areas shall be inspected and cleaned to reduce the potential for pollutants to enter the storm water conveyance system.
 4. Spill Prevention and Response - Identification of areas where significant materials can spill into or otherwise enter the storm water conveyance systems and their accompanying drainage points. Specific material handling procedures, storage requirements, spill clean up equipment and procedures should be identified, as appropriate. Internal notification procedures for spills of significant materials should be established.
 5. Storm Water Management Practices - Storm water management practices are practices other than those which control the source of pollutants. They include measures such as installing oil and grit separators, diverting storm water into retention basins, etc. Based on assessment of the potential of various sources to contribute pollutants, measures to remove pollutants from storm water discharge shall be implemented. In developing the plan, the following management practices shall be considered:
 - i. Containment - Storage within berms or other secondary containment devices to prevent leaks and spills from entering storm water runoff;
 - ii. Oil & Grease Separation - Oil/water separators, booms, skimmers or other methods to minimize oil contaminated storm water discharges;
 - iii. Debris & Sediment Control - Screens, booms, sediment ponds or other methods to reduce debris and sediment in storm water discharges;
 - iv. Waste Chemical Disposal - Waste chemicals such as antifreeze, degreasers and used oils shall be recycled or disposed of in an approved manner and in a way which prevents them from entering storm water discharges.
 - v. Storm Water Diversion - Storm water diversion away from materials manufacturing, storage and other areas of potential storm water contamination;
 - vi. Covered Storage or Manufacturing Areas - Covered fueling operations, materials manufacturing and storage areas to prevent contact with storm water.
 6. Sediment and Erosion Prevention - The plan shall identify areas which due to topography, activities, or other factors, have a high potential for significant soil erosion and describe measures to limit erosion.
 7. Employee Training - Employee training programs shall inform personnel at all levels of responsibility of the components and goals of the storm water pollution control plan. Training should address topics such as spill response, good housekeeping and material management practices. The plan shall identify periodic dates for such training.
 8. Inspection Procedures - Qualified plant personnel shall be identified to inspect designated equipment and plant areas. A tracking or follow-up procedure shall be used to ensure appropriate response has been taken in response to an inspection. Inspections and maintenance activities shall be documented and recorded.

NPDES Permit No. IL0001589

Special Conditions

- G. The permittee shall conduct an annual facility inspection to verify that all elements of the plan, including the site map, potential pollutant sources, and structural and non-structural controls to reduce pollutants in industrial storm water discharges are accurate. Observations that require a response and the appropriate response to the observation shall be retained as part of the plan. Records documenting significant observations made during the site inspection shall be submitted to the Agency in accordance with the reporting requirements of this permit.
- H. This plan should briefly describe the appropriate elements of other program requirements, including Spill Prevention Control and Countermeasures (SPCC) plans required under Section 311 of the CWA and the regulations promulgated thereunder, and Best Management Programs under 40 CFR 125.100.
- I. The plan is considered a report that shall be available to the public under Section 308(b) of the CWA. The permittee may claim portions of the plan as confidential business information, including any portion describing facility security measures.
- J. The plan shall include the signature and title of the person responsible for preparation of the plan and include the date of initial preparation and each amendment thereto.

Construction Authorization

- K. Authorization is hereby granted to construct treatment works and related equipment that may be required by the Storm Water Pollution Prevention Plan developed pursuant to this permit.

This Authorization is issued subject to the following condition(s).

- 1. If any statement or representation is found to be incorrect, this authorization may be revoked and the permittee there upon waives all rights thereunder.
- 2. The issuance of this authorization (a) does not release the permittee from any liability for damage to persons or property caused by or resulting from the installation, maintenance or operation of the proposed facilities; (b) does not take into consideration the structural stability of any units or part of this project; and (c) does not release the permittee from compliance with other applicable statutes of the State of Illinois, or other applicable local law, regulations or ordinances.
- 3. Plans and specifications of all treatment equipment being included as part of the stormwater management practice shall be included in the SWPPP.
- 4. Construction activities which result from treatment equipment installation, including clearing, grading and excavation activities which result in the disturbance of one acre or more of land area, are not covered by this authorization. The permittee shall contact the IEPA regarding the required permit(s).

REPORTING

- L. The facility shall submit an annual inspection report to the Illinois Environmental Protection Agency. The report shall include results of the annual facility inspection which is required by Part G of the Storm Water Pollution Prevention Plan of this permit. The report shall also include documentation of any event (spill, treatment unit malfunction, etc.) which would require an inspection, results of the inspection, and any subsequent corrective maintenance activity. The report shall be completed and signed by the authorized facility employee(s) who conducted the inspection(s).
- M. The first report shall contain information gathered during the one year time period beginning with the effective date of coverage under this permit and shall be submitted no later than 60 days after this one year period has expired. Each subsequent report shall contain the previous year's information and shall be submitted no later than one year after the previous year's report was due.

NPDES Permit No. IL0001589

Special Conditions

N. Annual inspection reports shall be mailed to the following address:

Illinois Environmental Protection Agency
Bureau of Water
Compliance Assurance Section
Annual Inspection Report
1021 North Grand Avenue East
Post Office Box 19276
Springfield, Illinois 62794-9276

O. If the facility performs inspections more frequently than required by this permit, the results shall be included as additional information in the annual report.

SPECIAL CONDITION 11. The Permittee shall record monitoring results on Discharge Monitoring Report (DMR) Forms using one such form for each outfall each month.

In the event that an outfall does not discharge during a monthly reporting period, the DMR Form shall be submitted with no discharge indicated.

The Permittee may choose to submit electronic DMRs (eDMRs) instead of mailing paper DMRs to the IEPA. More information, including registration information for the eDMR program, can be obtained on the IEPA website, <http://www.epa.state.il.us/water/edmr/index.html>.

The completed Discharge Monitoring Report forms shall be submitted to IEPA no later than the 15th day of the following month, unless otherwise specified by the permitting authority.

Permittees not using eDMRs shall mail Discharge Monitoring Reports with an original signature to the IEPA at the following address:

Illinois Environmental Protection Agency
Division of Water Pollution Control
1021 North Grand Avenue East
Post Office Box 19276
Springfield, Illinois 62794-9276

Attention: Compliance Assurance Section, Mail Code # 19

SPECIAL CONDITION 12. For the purpose of this permit, discharges from outfall 002 are limited to overflow from the stormwater retention basin, free from additional process or other discharges.

SPECIAL CONDITION 13. The permittee shall monitor the nitrogen concentration of its oil feed stocks and report the concentrations to the Agency on an annual basis. Reports shall be submitted no later than 60 days after the end of the calendar year.

SPECIAL CONDITION 14. The permittee may use the upset provision as an affirmative defense provided all the requirements of 40 CFR 122.41(n) are met.

SPECIAL CONDITION 15. Discharge from this facility shall be in accordance with 35 Ill. Adm. Code Section 304.213 for ammonia nitrogen. This section requires that the discharge meet EAT limitations pursuant to 40 CFR 419.23, as well as ammonia nitrogen concentration limits of 9.4 mg/l as a monthly average and 26.0 mg/l as a daily maximum.

NPDES Permit No. IL0001589

Special Conditions

SPECIAL CONDITION 16. Storm Water Credit for Outfall 001:

An additional stormwater credit for the following parameters shall be calculated based on 100% of the stormwater flow as defined below.

	Pounds per 1000 gallons of stormwater	
<u>Parameter</u>	<u>Average</u>	<u>Maximum</u>
BOD	0.22	0.40
Total Suspended Solids	0.18	0.28
COD	1.5	3.0
Oil and Grease	0.067	0.13
Phenol	0.0014	0.0029
Cr (tot)	0.0018	0.0050
Cr (+6)	0.00023	0.00052

Dry Weather Flow – The average flow from the waste water treatment facility for the last three consecutive zero precipitation days. Previously collected storm water shall not be included.

Stormwater Flows – The stormwater runoff which is treated in the waste water treatment facility shall be defined as that portion of the flow greater than the dry weather flow.

In computing monthly average permit limits to include stormwater credit, the pound credit calculated above shall be averaged along with process pound limits over the 30 day period. Explanatory calculations and flow data shall be submitted together with discharge monitoring reports.

The stormwater credit does not authorize the permittee to exceed the concentration limits contained in effluent Limitations and Monitoring, Page 2.

SPECIAL CONDITION 17.

a) The discharge from outfall A01 shall be subject to the following limitations:

During the months of April through November, the discharge shall not exceed 90° F, except that one percent of the hours in any 12 month period may exceed 90° F but shall never exceed 93° F at any time.

The monthly average and monthly maximum value shall be reported on the DMR. The permittee shall also report the total number hours the temperature exceeds 90° F.

b) The waters receiving the discharge from outfall 001 are designated as Secondary Contact and Indigenous Aquatic Life Waters by Section 302.408, Illinois Administrative Code, Title 35, Chapter 1, Subtitle C, as amended. These waters shall meet the following standard:

Temperatures shall not exceed 93° F more than 5% of the time, or 100° F at any time at the edge of the mixing zone which is defined by Rule 302.102 of the above regulations.

The monthly maximum value shall be reported on the DMR form. In lieu of monitoring at the edge of the mixing zone, the permittee may demonstrate compliance with this paragraph by monitoring at outfall 001.

SPECIAL CONDITION 18. The permittee was granted a variance from the water quality standard for Total Dissolved Solids (TDS) for the discharge at outfall 001 in accordance with Illinois Pollution Control Board Order PCB 05-85. The permittee shall commence its study of downstream TDS concentrations in accordance with the schedule contained in this order. This permit may be modified to include any final limitations or monitoring requirements which may be necessary based on the results of the study, or future Illinois Pollution Control Board actions with result to Total Dissolved Solids water quality standards. This variance expires on December 15, 2009.

NPDES Permit No. IL0001589

Special Conditions

SPECIAL CONDITION 19:

- a. From the effective date of this permit until such time that the FCCU Scrubber System becomes operational, monitoring for Total Residual Chlorine (TRC) is only required during those times when breakpoint or super chlorination is used for short term ammonia treatment in the treated water basin. Prior to discharging from the treated water basin following chlorine treatment, the permittee shall take a grab sample from the basin to determine compliance with the TRC limit of 0.05 mg/l. The discharge from the basin shall then be sampled once per day using a grab sample, for a period of five days after resuming the discharge. The permittee shall submit an attachment to the DMR explaining the reason for the temporary chlorine treatment, the amount of chlorine used, and length of the temporary cessation of discharge. The maximum concentration recorded shall be reported on the DMR.
- b. The permittee shall notify the Agency in writing 30 days (or as soon as practicable) prior to the start of operation of the FCCU Scrubber Break Point Chlorination System. Upon start up of the break point chlorination system, the discharge from Outfall 001 shall be monitored on a continuous basis for Total Residual Chlorine and subject to a limit of 0.05 mg/l as an instantaneous maximum. The maximum recorded concentration shall be reported on the DMR.
- c. In the event that the continuous monitoring system is not functioning or need routine maintenance, the permittee may substitute a once per day grab sample at Outfall 001 until such time that the continuous analyzer is operational. The permittee shall include an attachment to the DMR explaining the reason and length of the outage.

SPECIAL CONDITION 20: For the purposes of compliance at Outfall 001, samples for hexavalent chromium shall be taken at a point prior to entering the aeration basin. Upon commencement of operation of the FCCU Scrubber System, the discharge from internal Outfall A01 shall also be sampled on a monthly basis for hexavalent chromium. Compliance with hexavalent chromium load limits at outfall 001 shall be determined by multiplying the concentration times the flow for Outfall A01 plus the concentration times the flow prior to entering the treated water basin.

Attachment to

Standard Conditions

Definitions

Act means the Illinois Environmental Protection Act, 415 ILCS 5 as Amended.

Agency means the Illinois Environmental Protection Agency.

Board means the Illinois Pollution Control Board.

Clean Water Act (formerly referred to as the Federal Water Pollution Control Act) means Pub. L. 92-500, as amended. 33 U.S.C. 1251 et seq.

CDD (National Pollutant Discharge Elimination System) means the national program for issuing, modifying, revoking and reissuing, terminating, monitoring and enforcing permits, and imposing and enforcing pretreatment requirements, under Sections 307, 402, 318 and 405 of the Clean Water Act.

EPA means the United States Environmental Protection Agency.

Daily Discharge means the discharge of a pollutant measured during a calendar day or any 24-hour period that reasonably represents the calendar day for purposes of sampling. For pollutants with limitations expressed in units of mass, the "daily discharge" is calculated as the total mass of the pollutant discharged over the day. For pollutants with limitations expressed in other units of measurements, the "daily discharge" is calculated as the average measurement of the pollutant over the day.

Maximum Daily Discharge Limitation (daily maximum) means the highest allowable daily discharge.

Average Monthly Discharge Limitation (30 day average) means the highest allowable average of daily discharges over a calendar month, calculated as the sum of all daily discharges measured during a calendar month divided by the number of daily discharges measured during that month.

Average Weekly Discharge Limitation (7 day average) means the highest allowable average of daily discharges over a calendar week, calculated as the sum of all daily discharges measured during a calendar week divided by the number of daily discharges measured during that week.

Best Management Practices (BMPs) means schedules of activities, prohibitions of practices, maintenance procedures, and other management practices to prevent or reduce the pollution of waters of the State. BMPs also include treatment requirements, operating procedures, and practices to control plant site runoff, spillage or leaks, sludge or waste disposal, or drainage from raw material storage.

Aliquot means a sample of specified volume used to make up a total composite sample.

Grab Sample means an individual sample of at least 100 milliliters collected at a randomly-selected time over a period not exceeding 15 minutes.

24 Hour Composite Sample means a combination of at least 8 sample aliquots of at least 100 milliliters, collected at periodic intervals during the operating hours of a facility over a 24-hour period.

8 Hour Composite Sample means a combination of at least 3 sample aliquots of at least 100 milliliters, collected at periodic intervals during the operating hours of a facility over an 8-hour period.

Flow Proportional Composite Sample means a combination of sample aliquots of at least 100 milliliters collected at periodic intervals such that either the time interval between each aliquot or the volume of each aliquot is proportional to either the stream flow at the time of sampling or the total stream flow since the collection of the previous aliquot.

- (1) Duty to comply. The permittee must comply with all conditions of this permit. Any permit noncompliance constitutes a violation of the Act and is grounds for enforcement action, permit termination, revocation and reissuance, modification, or for denial of a permit renewal application. The permittee shall comply with effluent standards or prohibitions established under Section 307(a) of the Clean Water Act for toxic pollutants within the time provided in the regulations that establish these standards or prohibitions, even if the permit has not yet been modified to incorporate the requirement.
- (2) Duty to reapply. If the permittee wishes to continue an activity regulated by this permit after the expiration date of this permit, the permittee must apply for and obtain a new permit. If the permittee submits a proper application as required by the Agency no later than 180 days prior to the expiration date, this permit shall continue in full force and effect until the final Agency decision on the application has been made.
- (3) Need to halt or reduce activity not a defense. It shall not be a defense for a permittee in an enforcement action that it would have been necessary to halt or reduce the permitted activity in order to maintain compliance with the conditions of this permit.
- (4) Duty to mitigate. The permittee shall take all reasonable steps to minimize or prevent any discharge in violation of this permit which has a reasonable likelihood of adversely affecting human health or the environment.
- (5) Proper operation and maintenance. The permittee shall at all times properly operate and maintain all facilities and systems of treatment and control (and related appurtenances) which are installed or used by the permittee to achieve compliance with conditions of this permit. Proper operation and maintenance includes effective performance, adequate funding, adequate operator staffing and training, and adequate laboratory and process controls, including appropriate quality assurance procedures. This provision requires the operation of back-up, or auxiliary facilities, or similar systems only when necessary to achieve compliance with the conditions of the permit.

(9) Permit revisions. This permit may be modified, amended and corrected, or terminated or renewed by the Agency pursuant to 40 CFR 122.62. This Act or a request by the permittee for a permit modification, revocation and reissuance, or termination, or a notification of planned changes or anticipated noncompliance, does not stay any permit condition.

(7) Property rights. This permit does not convey any property rights of any sort, or any exclusive privileges.

(8) Duty to provide information. The permittee shall furnish to the Agency within a reasonable time, any information which the Agency may request to determine whether cause exists for modifying, revoking and reissuing, or terminating this permit, or to determine compliance with the permit. The permittee shall also furnish to the Agency, upon request, copies of records required to be kept by this permit.

(9) Inspection and entry. The permittee shall allow an authorized representative of the Agency, upon the presentation of credentials and other documents as may be required by law, to:

- (a) Enter upon the permittee's premises where a regulated facility or activity is located or conducted, or where records must be kept under the conditions of this permit;
- (b) Have access to and copy, at reasonable times, any records that must be kept under the conditions of this permit;
- (c) Inspect at reasonable times any facilities, equipment (including monitoring and control equipment), practices, or operations regulated or required under this permit; and
- (d) Sample or monitor at reasonable times, for the purpose of assuring permit compliance, or as otherwise authorized by the Act, any substances or parameters at any location.

(10) Monitoring and records.

- (a) Samples and measurements taken for the purpose of monitoring shall be representative of the monitored activity.
- (b) The permittee shall retain records of all monitoring information, including all calibration and maintenance records, and all original strip chart recordings for continuous monitoring instrumentation, copies of all reports required by this permit, and records of all data used to complete the application for this permit, for a period of at least 3 years from the date of this permit, measurement, report or application. This period may be extended by request of the Agency at any time.
- (c) Records of monitoring information shall include:
 - (1) The date, exact place, and time of sampling or measurements;
 - (2) The individual(s) who performed the sampling or measurements;
 - (3) The date(s) analyses were performed;
 - (4) The individual(s) who performed the analyses;
 - (5) The analytical techniques or methods used; and
 - (6) The results of such analyses.
- (d) Monitoring must be conducted according to test procedures approved under 40 CFR Part 136, unless other test procedures have been specified in this permit. Where no test procedure under 40 CFR Part 136 has been approved, the permittee must submit to the Agency a test method for approval. The permittee shall calibrate and perform maintenance procedures on all monitoring and analytical instrumentation at intervals to ensure accuracy of measurements.

(11) Signatory requirement. All applications, reports or information submitted to the Agency shall be signed and certified.

(a) Application. All permit applications shall be signed as follows:

- (1) For a corporation: by a principal executive officer of at least the level of vice president or a person or position having overall responsibility for environmental matters for the corporation;
- (2) For a partnership or sole proprietorship: by a general partner or the proprietor, respectively; or
- (3) For a municipality, State, Federal, or other public agency: by either a principal executive officer or ranking elected official.

(b) Reports. All reports required by permits, or other information requested by the Agency shall be signed by a person described in paragraph (a) or by a duly authorized representative of that person. A person is a duly authorized representative only if:

- (1) The authorization is made in writing by a person described in paragraph (a); and
- (2) The authorization specifies either an individual or a position responsible for the overall operation of the facility, from which the discharge originates, such as a plant manager, superintendent or person of equivalent responsibility; and
- (3) The written authorization is submitted to the Agency.

APPENDIX B

LEMONT REFINERY DATA – 1997 TO 2007

CITGO REFINERY
Annual Sulfur and Nitrogen

Year	% S	% N
1991	1.30	0.18
1992	1.40	0.19
1993	1.46	0.20
1994	1.38	0.19
1995	1.44	0.21
1996	1.49	0.20
1997	1.71	0.20
1998	1.97	0.21
1999	2.06	0.24
2000	2.29	0.20
2001	2.45	0.19
2002	2.55	0.25
2003	2.47	0.15
2004	2.50	0.18
2005	2.66	0.18
2006	2.68	0.18

CITGO REFINERY
Barrels of Oil Processed Per Day

Year	Crude Throughput
1997	152,698
1998	149,990
1999	145,886
2000	152,558
2001	98,070
2002	58,909
2003	162,353
2004	160,473
2005	159,181
2006	146,040
2007	

CITGO REFINERY
Annual Sulfur and Nitrogen

Year	% S	ppm N
1997	1.71	1,986
1998	1.97	2,102
1999	2.06	2,347
2000	2.29	1,978
2001	2.45	1,926
2002	2.55	2,049
2003	2.47	1,510
2004	2.50	1,827
2005	2.66	1,795
2006	2.68	1,782
2007		

CITGO REFINERY
Wastewater Flowrate (MGD)

Year	Flow
1997	3.47
1998	4.03
1999	3.73
2000	4.19
2001	3.86
2002	3.52
2003	4.27
2004	4.49
2005	4.28
2006	4.66
2007	

CITGO REFINERY
Annual Average and Maximum Monthly Ammonia,
Pounds per day

Year	Annual Average	Maximum Month
1997	35	576
1998	50	276
1999	64	1146
2000	80	485
2001	42	522
2002	38	590
2003	99	844
2004	62	590
2005	116	656
2006	139	846
2007		

CITGO REFINERY
Yearly Average Influent Ammonia Conc.

Year	Ammonia Conc., ppm
1997	0.85
1998	0.96
1999	1.45
2000	1.22
2001	0.79
2002	0.52
2003	0.64
2004	0.47
2005	0.81
2006	0.70
2007	

CITGO REFINERY
Effluent Ammonia Discharge Concentrations

Year	Yrly Ave Amm. Conc.	Mo. Max Amm Conc.	Dly Max Amm Conc.
1997	1.28	6.20	20.9
1998	1.60	3.42	9.61
1999	2.46	11.04	25.8
2000	2.31	5.83	20.2
2001	1.30	4.07	19.6
2002	1.24	4.81	17.1
2003	2.85	7.99	20.6
2004	2.43	12.10	17.7
2005	3.63	9.19	15.4
2006	3.50	9.31	16.4
2007			

CITGO REFINERY
Net Ammonia Load To S&S Canal

Date	Eff Ave Ammonia lbs/day	Int Ave Ammonia lbs/day	Net Discharge Eff lbs/day	Yearly Ave Effluent lbs/day	Yearly Ave Influent lbs/day	Yearly Ave Net Eff lbs/day
Aug '97	20	9	11			
Sept '97	171	16	155			
Oct '97	13	12	1			
Nov '97	27	53	-26			
Dec '97	31	29	2	36	35	1
Jan '98	32	33	-1			
Feb '98	24	63	-39			
Mar '98	31	16	15			
Apr '98	37	19	18			
May '98	68	20	48			
June '98	90	24	66			
July '98	52	24	28			
Aug '98	64	38	26			
Sept '98	73	25	48			
Oct '98	41	23	18			
Nov '98	39	22	17			
Dec '98	54	11	43	50	27	23
Jan '99	163	21	142			
Feb '99	189	78	111			
Mar '99	54	43	11			
Apr '99	46	33	13			
May '99	60	44	16			
June '99	29	55	-26			
July '99	36	47	-11			
Aug '99	27	30	-3			
Sept '99	35	51	-16			
Oct '99	17	75	-58			
Nov '99	43	70	-27			
Dec '99	71	120	-49	64	56	8
Jan '00	76	59	17			
Feb '00	78	70	8			
Mar '00	136	71	65			
Apr '00	88	59	29			
May '00	47	21	26			
June '00	132	18	114			
July '00	104	16	88			
Aug '00	77	77	0			
Sept '00	26	48	-22			
Oct '00	13	37	-24			
Nov '00	22	79	-57			
Dec '00	80	41	39	73	50	24

Jan '01	122	70	52			
Feb '01	22	52	-30			
Mar '01	58	46	12			
Apr '01	20	35	-15			
May '01	122	27	95			
June '01	16	38	-22			
July '01	36	56	-20			
Aug '01	14	12	2			
Sept '01	19	13	6			
Oct '01	17	10	7			
Nov '01	21	10	11			
Dec '01	38	14	24	42	32	10
Jan '02	20	21	-1			
Feb '02	31	30	1			
Mar '02	12	32	-20			
Apr '02	65	23	42			
May '02	36	13	23			
June '02	175	18	156			
July '02	16	10	6			
Aug '02	10	14	-4			
Sept '02	34	14	20			
Oct '02	17	27	-10			
Nov '02	25	5	20			
Dec '02	11	22	-11	38	19	18
Jan-03	113	19	94			
Feb-03	34	18	16			
Mar-03	49	17	32			
Apr-03	58	45	14			
May-03	267	17	250			
Jun-03	124	20	104			
Jul-03	41	28	13			
Aug-03	21	20	1			
Sep-03	23	13	10			
Oct-03	52	21	31			
Nov-03	215	8	207			
Dec-03	193	9	184	99	20	80
Jan-04	243	13	230			
Feb-04	20	69	-49			
Mar-04	28	38	-10			
Apr-04	12	15	-3			
May-04	20	14	6			
Jun-04	13	9	4			
Jul-04	15	14	1			
Aug	17	8	9			
Sep-04	12	11	1			
Oct-04	89	8	81			
Nov-04	72	22	50			
Dec-04	199	30	169	62	21	41

Jan-05	113	65	48			
Feb-05	27	69	-42			
Mar-05	23	80	-57			
Apr-05	24	52	-28			
May-05	18	22	-4			
Jun-05	20	15	5			
Jul-05	285	19	266			
Aug-05	171	17	154			
Sep-05	196	14	182			
Oct-05	244	11	233			
Nov-05	154	31	123			
Dec-05	122	52	70	116	37	79
Jan-06	250	46	204			
Feb-06	403	29	374			
Mar-06	287	17	270			
Apr-06	284	19	265			
May-06	241	25	216			
Jun-06	26	22	4			
Jul-06	75	86	-11			
Aug-06	15	12	3			
Sep-06	26	16	10			
Oct-06	16	12	4			
Nov-06	18	15	3			
Dec-06	21	38	-17	139	28	110
Jan-07	61	26	35			
Feb-07	68	45	23			
Mar-07	76	80	-4			
Apr-07	148	21	127			
May-07	95	28	67			
Jun-07	138	21	117			
Jul-07	140	12	128	104	33	70

g:nh398-net ammonia to S&S Canal

CITGO REFINERY
Influent From S&S Canal

Date	Ave Flow,MGD	Ave ppm NH3N	Ave Lbs NH3N
Jan '97	4.97	1.33	55
Feb '97	4.32	1.85	67
Mar '97	4.22	1.19	42
Apr '97	4.79	0.62	25
May '97	4.70	1.05	41
June '97	4.88	0.49	20
July '97	4.41	0.40	15
Aug '97	3.83	0.29	9
Sept '97	4.51	0.43	16
Oct '97	4.54	0.31	12
Nov '97	4.21	1.51	53
Dec '97	4.76	0.73	29
Average	4.51	1	32
Jan '98	4.98	0.80	33
Feb '98	4.87	1.55	63
Mar '98	4.51	0.43	16
Apr '98	4.89	0.46	19
May '98	3.23	0.75	20
June '98	4.29	0.66	24
July '98	4.97	0.59	24
Aug '98	5.09	0.89	38
Sept '98	5.01	0.60	25
Oct '98	4.64	0.60	23
Nov '98	4.72	0.57	22
Dec '98	4.44	0.29	11
Average	4.64	0.68	27
Jan '99	4.35	0.58	21
Feb '99	4.50	2.07	78
Mar '99	4.95	1.03	43
Apr '99	3.99	1.00	33
May '99	4.80	1.09	44
June '99	5.25	1.25	55
July '99	5.65	0.99	47
Aug '99	5.14	0.70	30
Sept '99	4.64	1.31	51
Oct '99	4.44	2.02	75
Nov '99	4.56	1.85	70
Dec '99	4.10	3.50	120
Average	4.70	1.45	55

Jan '00	4.51	1.58	59
Feb '00	5.64	1.49	70
Mar '00	5.49	1.56	71
Apr '00	5.00	1.41	59
May '00	4.89	0.51	21
June '00	4.52	0.48	18
July '00	5.37	0.35	16
Aug '00	5.23	1.76	77
Sept '00	4.52	1.28	48
Oct '00	4.45	1.01	37
Nov '00	4.27	2.23	79
Dec '00	4.86	1.01	41
Average	4.90	1.22	50
Jan '01	5.36	1.56	70
Feb '01	4.96	1.25	52
Mar '01	4.86	1.14	46
Apr '01	5.00	0.84	35
May '01	5.56	0.58	27
June '01	4.93	0.93	38
July '01	5.46	1.22	56
Aug '01	3.52	0.40	12
Sept '01	3.10	0.52	13
Oct '01	3.43	0.36	10
Nov '01	4.37	0.27	10
Dec '01	4.16	0.40	14
Average	4.56	0.79	32
Jan '02	4.22	0.60	21
Feb '02	4.29	0.83	30
Mar '02	4.40	0.87	32
Apr '02	4.23	0.66	23
May '02	4.21	0.38	13
June '02	5.47	0.40	18
July '02	5.61	0.22	10
Aug '02	5.78	0.29	14
Sept '02	5.78	0.30	14
Oct '02	3.79	0.86	27
Nov '02	2.25	0.24	5
Dec '02	4.11	0.63	22
Average	4.51	0.52	19

Jan-03	5.36	0.37	17
Feb-03	5.66	0.92	43
Mar-03	5.35	1.26	56
Apr-03	5.15	1.04	45
May-03	4.49	0.45	17
Jun-03	5.00	1.45	60
Jul-03	4.36	0.28	10
Aug-03	4.05	0.58	20
Sep-03	5.46	0.29	13
Oct-03	5.35	0.48	21
Nov-03	3.52	0.28	8
Dec-03	3.49	0.31	9
Average	4.77	0.64	27
Jan-04	4.03	0.40	13
Feb-04	6.77	1.23	69
Mar-04	5.78	0.80	38
Apr-04	5.77	0.32	15
May-04	5.22	0.32	14
Jun-04	4.51	0.23	9
Jul-04	5.18	0.33	14
Aug-04	4.82	0.21	8
Sep-04	3.39	0.40	11
Oct-04	4.73	0.21	8
Nov-04	4.54	0.57	22
Dec-04	5.48	0.65	30
Average	5.02	0.47	21.05
Jan-05	5.00	1.55	65
Feb-05	5.51	1.51	69
Mar-05	5.92	1.62	80
Apr-05	6.31	0.98	52
May-05	5.75	0.46	22
Jun-05	6.23	0.28	15
Jul-05	5.65	0.41	19
Aug-05	5.56	0.36	17
Sep-05	5.94	0.28	14
Oct-05	5.31	0.24	11
Nov-05	4.87	0.77	31
Dec-05	4.94	1.26	52
Average	5.58	0.81	37

Jan-06	5.27	1.05	46
Feb-06	5.19	0.67	29
Mar-06	4.64	0.45	17
Apr-06	4.84	0.46	19
May-06	4.81	0.63	25
Jun-06	4.69	0.56	22
Jul-06	4.73	2.18	86
Aug-06	5.47	0.27	12
Sep-06	5.17	0.38	16
Oct-06	3.29	0.43	12
Nov-06	3.98	0.44	15
Dec-06	5.50	0.83	38
Average	4.80	0.70	28.10
Jan-07	5.40	0.57	26
Feb-07	5.30	1.02	45
Mar-07	5.75	1.67	80
Apr-07	4.84	0.53	21
May-07	5.95	0.57	28
Jun-07	5.93	0.43	21
Jul-07	4.35	0.33	12
Average	5.36	0.73	33.37

g:nh398-Influent data

CITGO REFINERY
Effluent Ammonia, Ph, and Temperature

Date	Flow	Ave ppm NH3N	Ave Lbs NH3N	pH	Temp
Jan '97	4.31	0.48	17	7.1	65
Feb '97	4.95	0.59	24	7.1	67
Mar '97	4.43	0.46	17	7.3	71
Apr '97	3.73	0.57	18	7.5	70
May '97	3.16	0.44	12	7.4	74
June '97	2.74	0.66	15	7.4	80
July '97	2.43	2.13	43	7.4	86
Aug '97	3.43	0.69	20	7.4	84
Sept '97	3.06	6.69	171	7.3	82
Oct '97	2.82	0.56	13	7.3	75
Nov '97	2.96	1.09	27	7.3	70
Dec '97	3.59	1.03	31	7.1	72
Average		1.3	34		
Jan '98	4.95	0.77	32	7.0	74
Feb '98	4.11	0.69	24	7.1	72
Mar '98	4.87	0.76	31	7.2	70.9
Apr '98	4.18	1.07	37	7.2	75
May '98	3.73	2.18	68	7.1	80
June '98	3.14	3.42	90	7.1	85
July '98	3.99	1.55	52	7.2	88
Aug '98	3.62	2.13	64	7.2	89.5
Sept '98	3.78	2.31	73	6.7	84.6
Oct '98	3.81	1.29	41	6.5	75
Nov '98	3.74	1.24	39	6.6	62
Dec '98	4.44	1.45	54	6.8	62.5
Average		1.57	50		
Jan '99	1.77	11.05	163	7.2	53
Feb '99	4.45	5.09	189	7.1	68
Mar '99	4.08	1.60	54	7.0	68.5
Apr '99	4.26	1.30	46	6.7	72.6
May '99	5.33	1.36	60	6.8	78.1
June '99	4.32	0.8	29	7.15	82.2
July '99	3.69	1.17	36	7.3	90.8
Aug '99	3.49	0.93	27	7.1	86.7
Sept '99	3.56	1.26	37	6.8	82.9
Oct '99	3.48	0.58	17	6.8	72.6
Nov '99	3.37	1.52	43	6.75	70.4
Dec '99	2.97	2.86	71	6.8	60.9
Average		2.46	64		

Jan '00	3.45	2.64	76	6.8	66.1
Feb '00	4.31	2.16	78	6.7	69.6
Mar '00	3.98	4.10	136	6.8	72.4
Apr '00	4.82	2.18	88	6.7	71.4
May '00	5.42	1.03	47	7.1	78.0
June '00	5.68	2.79	132	7.1	77.9
July '00	4.76	2.62	104	7.15	85.5
Aug '00	3.91	2.36	77	7.2	84.0
Sept '00	3.84	0.80	26	7.15	79.3
Oct '00	3.14	0.48	13	7.1	75.9
Nov '00	3.72	0.71	22	7.0	68.9
Dec '00	3.29	5.82	160	7.0	61.8
Average		2.31	80		
Jan '01	4.98	2.93	122	7.2	64.7
Feb '01	5.89	0.44	22	7.0	66.8
Mar '01	4.44	1.57	58	6.6	67.5
Apr '01	4.56	0.52	20	6.8	73.2
May '01	3.60	4.07	122	6.8	78.9
June '01	2.88	0.68	16	6.7	85.0
July '01	3.08	1.39	36	6.8	88.6
Aug '01	3.33	0.52	14	6.8	84.6
Sept '01	3.01	0.75	19	6.7	76.4
Oct '01	4.43	0.45	17	6.7	74.0
Nov '01	3.08	0.80	21	6.7	69.8
Dec '01	3.03	1.50	38	6.5	65.5
Average		1.30	42		
Jan '02	3.15	0.78	20	6.5	64.2
Feb '02	3.22	1.15	31	7.2	65.3
Mar '02	4.41	0.32	12	7.2	67.4
Apr '02	4.64	1.67	65	7.4	72.1
May '02	4.53	0.95	36	7.3	73.2
June '02	4.35	4.81	175	7.3	83.5
July '02	4.07	0.48	16	7.2	89.8
Aug '02	3.87	0.32	10	7.2	87.7
Sept '02	3.72	1.10	34	7.2	83.2
Oct '02	2.69	0.76	17	7.0	68.8
Nov '02	1.61	1.87	25	7.2	59.2
Dec '02	1.95	0.69	11	7.1	60.8
Average		1.24	38		

Jan-03	4.29	3.16	113	7.0	62.8
Feb-03	3.99	1.01	34	7.2	64.1
Mar-03	4.45	1.31	49	6.9	71.2
Apr-03	4.26	1.64	58	6.9	73.5
May-03	5.24	6.10	267	6.6	77.5
Jun-03	4.03	3.69	124	6.6	81.6
Jul-03	4.73	1.05	41	6.6	84.7
Aug-03	5.03	0.51	21	6.6	86.9
Sep-03	4.00	0.70	23	6.5	81.1
Oct-03	3.22	1.92	52	6.5	76.8
Nov-03	5.07	5.08	215	6.4	70.8
Dec-03	2.89	7.99	193	6.6	71.3
Average		2.85	99		
Jan-04	5.09	5.72	243	6.6	70.1
Feb-04	5.36	0.45	20	6.5	70.4
Mar-04	5.52	0.60	28	6.6	72.2
Apr-04	4.26	0.35	12	6.5	75.3
May-04	4.98	0.49	20	6.5	79.5
Jun-04	5.25	0.29	13	6.6	82.4
Jul-04	4.41	0.42	15	6.5	86.6
Aug-04	4.08	0.51	17	6.6	84.4
Sep-04	3.58	0.40	12	6.5	81.6
Oct-04	3.39	3.14	89	6.9	73.6
Nov-04	2.89	12.10	292	6.5	72.2
Dec-04	5.05	4.72	199	6.5	67.2
Average		2.43	80		
Jan-05	5.90	2.29	113	6.4	67.4
Feb-05	5.15	0.63	27	6.4	72.5
Mar-05	4.88	0.57	23	7.0	68.2
Apr-05	5.30	0.54	24	7.4	75.4
May-05	3.86	0.57	18	7.6	77.5
Jun-05	3.67	0.65	20	7.6	86.5
Jul-05	3.89	8.79	285	7.7	87.7
Aug-05	3.88	5.28	171	7.5	86.8
Sep-05	3.55	6.62	196	7.5	81.4
Oct-05	3.18	9.19	244	7.7	74.4
Nov-05	3.54	5.23	154	7.7	71.0
Dec	4.59	3.19	122	7.5	68.1
Average		3.63	116		

Jan-06	5.40	5.56	250	7.38	72.1
Feb-06	5.19	9.31	403	7.56	71.8
Mar-06	4.60	7.49	287	7.38	73.4
Apr-06	4.81	7.07	284	7.43	76.5
May-06	4.14	6.99	241	7.24	79.0
Jun-06	4.36	0.71	26	7.58	82.8
Jul-06	3.67	2.44	75	7.64	88.0
Aug-06	4.55	0.40	15	7.50	88.6
Sep-06	5.28	0.60	26	7.36	79.9
Oct-06	4.40	0.44	16	7.60	73.3
Nov-06	3.62	0.58	18	7.72	70.4
Dec-06	5.89	0.42	21	7.56	68.9
Average		3.50	139		
Jan-07	5.26	1.39	61	7.5	69.1
Feb-07	4.65	1.75	68	7.6	68.8
Mar-07	6.20	1.47	76	7.5	77.1
Apr-07	5.86	3.02	148	7.4	78.9
May-07	4.43	2.57	95	7.4	86.3
Jun-07	3.94	4.21	138	7.4	90.8
Jul-07	4.56	3.67	140	7.4	89.5
Average		2.58	104		

g:nh398-effluent data

APPENDIX C
USGS AND MWRDGC DATA – 1999 TO 2006

Station list Available data

ILLINOIS RIVER BASIN

05536995 CHICAGO SANITARY AND SHIP CANAL AT ROMEOVILLE, IL

LOCATION.--Lat 41°38'26", long 88°03'38", in SE1/4SW1/4 sec.35, T.37 N., R.10 E., Will County, Hydrologic Unit 07120004, on left bank 40 ft upstream from bridge on Romeoville Road in Romeoville, 5.2 mi upstream from Lockport Lock and Dam, and at mile 6.2.

DRAINAGE AREA.--739 mi².

PERIOD OF RECORD.--Water years 1974-77, 1987-92, March to September 1999.

DATE	AGENCY ANA-LYZING SAMPLE (CODE NUMBER) (00028)	AGENCY COL-LECTING SAMPLE (CODE NUMBER) (00027)	DIS-CHARGE, INST. CUBIC FEET PER SECOND (00061)	WATER-QUALITY			PH WATER WHOLE FIELD (STANDARD UNITS) (00400)	SPE-CIFIC CON-DUCT-ANCE (US/CM) (00095)	TEMPER-ATURE AIR (DEG C) (00020)	TEMPER-ATURE WATER (DEG C) (00010)
				BARO-METRIC PRES-SURE (MM OF HG) (00025)	OXYGEN, DIS-SOLVED (PER-CENT SATUR-ATION) (00301)	OXYGEN, DIS-SOLVED (MG/L) (00300)				
MAR 1999										
02...	80020	81700	2410	744	60	6.6	7.7	1200	5.0	9.7
APR										
07...	80020	81700	1700	747	58	5.7	7.5	1160	11.0	15.0
MAY										
04...	80020	81700	2660	741	73	7.0	7.5	929	22.0	15.6
JUN										
17...	80020	80020	6200	753	--	--	7.4	--	16.0	--
JUL										
06...	80020	81700	2680	745	42	3.2	7.3	715	28.5	27.2
27...	80020	81700	3150	744	43	3.3	7.0	575	31.3	28.1
AUG										
30...	80020	81700	6320	751	60	4.7	7.1	652	21.5	26.3
SEP										
28...	80020	81700	8910	746	47	4.0	7.1	729	17.0	22.2
	HARD-NESS TOTAL (MG/L) AS CACO ₃ (00900)	HARD-NESS NONCARB DISSOLV FLD. AS CACO ₃ (MG/L) (00904)	CALCIUM DIS-SOLVED (MG/L) AS CA (00915)	MAGNE-SIUM, DIS-SOLVED (MG/L) AS MG (00925)	POTAS-SIUM, DIS-SOLVED (MG/L) AS K (00935)	SODIUM AD-SORP-TION RATIO (00931)	SODIUM, DIS-SOLVED (MG/L) AS NA (00950)	ALKA-LINITY WAT DIS TOT IT FIELD (MG/L AS CACO ₃) (39086)	BICAR-BONATE WATER DIS IT FIELD (MG/L AS HCO ₃) (00453)	CHLO-RIDE, DIS-SOLVED (MG/L) AS CL (00940)
MAR 1999										

Electronic Filing - Received, Clerk's Office, March 18, 2008

05536995 DATA: Chemical and Microbiological Tabular Data AS 2008-008 * * * * *

DATE	240	97	61	22	6.4	4	147	144	175	240
APR 02...	280	120	68	26	7.0	3	122	160	195	190
MAY 04...	250	89	60	25	5.5	2	83	662	197	130
JUN 17...	180	73	46	17	5.0	2	65	114	135	99
JUL 06...	200	77	52	18	6.7	2	69	128	156	100
JUL 27...	160	55	41	14	4.8	2	54	106	130	27
AUG 30...	170	57	44	16	5.7	2	60	118	143	77
SEP 28...	180	65	44	16	7.2	2	68	112	138	85

DATE	FLUORIDE, DIS-SOLVED (MG/L AS F) (00950)	SILICA, DIS-SOLVED (MG/L AS SiO ₂) (00955)	SULFATE DIS-SOLVED (MG/L AS SO ₄) (00945)	NITROGEN, AMMONIA DIS-SOLVED (MG/L AS N) (00608)	NITROGEN, AMMONIA + ORGANIC DIS. (MG/L AS N) (00623)	NITROGEN, AMMONIA + ORGANIC TOTAL (MG/L AS N) (00625)	NITROGEN DIS-SOLVED (MG/L AS N) (00602)	NITROGEN, NITRATE DIS-SOLVED (MG/L AS N) (00618)	NITROGEN, NO ₂ +NO ₃ DIS-SOLVED (MG/L AS N) (00631)	NITROGEN, ORGANIC DIS-SOLVED (MG/L AS N) (00607)
MAR 1999										
APR 02...	.82	4.9	94	1.47	2.7	2.2	7.6	4.62	4.92	1.2
APR 07...	.91	4.9	110	.534	.93	1.6	8.8	7.74	7.90	.40
MAY 04...	.57	6.1	86	.317	.94	.94	4.6	3.58	3.69	.62
JUN 17...	.54	5.0	60	.410	1.2	1.2	5.1	3.81	3.91	.81
JUL 06...	.71	4.3	70	.391	.95	1.0	5.3	4.19	4.36	.56
JUL 27...	.62	3.7	59	.383	.95	.97	4.1	3.07	3.17	.57
AUG 30...	.70	4.7	62	.392	.88	1.4	4.9	3.86	3.98	.49
SEP 28...	.91	3.6	84	.115	1.1	2.0	7.9	6.64	6.84	.98

DATE	NITROGEN, ORGANIC TOTAL (MG/L AS N) (00605)	NITROGEN, TOTAL (MG/L AS N) (00600)	NITROGEN, NITRITE DIS-SOLVED (MG/L AS N) (00613)	PHOSPHATE, ORTHO, DIS-SOLVED (MG/L AS PO ₄) (00660)	PHOSPHORUS, DIS-SOLVED (MG/L AS P) (00666)	PHOSPHORUS, ORTHO, DIS-SOLVED (MG/L AS P) (00671)	PHOSPHORUS, TOTAL (MG/L AS P) (00665)	GAGE HEIGHT (FEET) (00065)	SOLIDS, RESIDUE AT 180 DEG. C DIS-SOLVED (MG/L) (70300)	IRON, DIS-SOLVED (UG/L AS FE) (01046)
MAR 1999										
APR 02...	.73	7.1	.306	3.4	1.17	1.11	1.20	25.59	714	33
APR 07...	1.1	9.5	.162	4.8	.091	1.55	1.67	25.52	682	25
MAY 04...	.62	4.6	.111	1.6	.539	.515	.629	25.64	546	38
JUN 17...	.83	5.2	.104	1.6	.650	.538	.716	24.71	427	24

JUL	06...	.60	5.4	.171	2.7	1.02	.883	1.04	25.53	448	E9.0
	27...	.59	4.1	.105	1.8	.610	.592	.742	25.81	338	18
AUG	30...	.96	5.3	.120	3.3	1.05	1.07	.972	24.86	379	12
SEP	28...	1.9	8.9	.200	5.4	2.05	1.77	2.66	25.21	427	16

DATE	MANGANESE, DIS-SOLVED (UG/L AS MN) (01056)	SEDIMENT, SUS-PENDED (MG/L) (80154)	SED. SUSP. SIEVE DIAM. % FINER THAN .062 MM (70331)	NUMBER OF SAM-PLING POINTS (COUNT) (00063)	PURPOSE SITE VISIT, (CODE) (50280)	QUALITY ASSUR-ANCE DATA TOR CODE (99111)	REP-LICATE TYPE (CODE) (99105)	SAMPLE PURPOSE CODE (71999)	SAMPLER TYPE (CODE) (84164)	SAM-PLING METHOD, CODES (82398)
MAR 1999										
APR 02...	34	67	95	5	1001	1	--	15.00	3060	10
APR 07...	31	112	98	3	1001	1	--	15.00	3060	10
MAY 04...	26	77	100	6	1001	30	30.00	15.00	3060	10
JUN 17...	27	63	100	6	1001	1	--	15.00	3060	10
JUL 06...	22	66	95	3	1001	1	--	15.00	3060	10
JUL 27...	25	59	97	3	1001	1	--	15.00	3060	10
AUG 30...	25	57	95	3	1001	1	--	15.00	3060	10
SEP 28...	17	195	92	6	1003	1	--	15.00	3052	10

Table of Contents Introduction Station Descriptions Surface-Water Data Ground-Water Data Meteorological Data Biological Data

Station list Available data

ILLINOIS RIVER BASIN

05536995 CHICAGO SANITARY AND SHIP CANAL AT ROMEOVILLE, IL

LOCATION.-- Lat 41°38'27", long 88°03'35", in SE1/4SW1/4 sec.35, T.37 N., R.10 E., Will County, Hydrologic Unit 07120004, on left bank 40 ft upstream from bridge on Romeoville Road in Romeoville, 5.2 mi upstream from Lockport Lock and Dam, and at mile 6.2.

DRAINAGE AREA.-- 739 mi².

PERIOD OF RECORD.--

SURFACE-WATER DISCHARGE AND STAGE

DISCHARGE: October 1984 to current year.

STAGE: Water years 1994-2000.

SURFACE-WATER QUALITY

CHEMICAL: Water years 1987-92 and 1999-2000.

WATER TEMPERATURE: Water years 1974-77.

REVISED RECORDS.-- WDR IL-86-2: 1985. WDR IL-89-2: 1986. WDR IL-92-2: 1986-89.

GAGE.-- Acoustical flowmeter and phone telemeter. Datum of gage is 551.89 ft above sea level (U.S. Army Corps of Engineers bench mark).

REMARKS.-- Estimated daily discharges determined from a regression relation between present site and the previous site 5.2 mi downstream.

This gaging station provides flow data essential to determine Illinois' diversion of Lake Michigan water. A U.S. Supreme Court Decree limits Illinois' diversion to an average of 3,200 ft³/s. Illinois' diversion includes water diverted from the lake for domestic water supply, for navigation and water-quality improvement in the Chicago Sanitary and Ship Canal system, and the stormwater runoff from a 673 mi² diverted watershed area. Flows recorded at this station also include nondiversion flows.

EXTREMES FOR PERIOD RECORD.--

SURFACE-WATER DISCHARGE AND STAGE: Maximum discharge, 19,466 ft³/s, Feb. 21, 1997, gage-height, 23.95 ft; maximum gage-height, 26.43 ft, Feb. 4, 1996; minimum discharge, no flow or periods of reverse flow at times in most years.

REMARKS FOR CURRENT YEAR.-- Sampled as part of the Upper Illinois River Basin (UIRB) National Water Quality Assessment Program (NAWQA).

SURFACE-WATER QUALITY													
DATE	TIME	AGENCY ANALYZING SAMPLE NUMBER (00028)	AGENCY COLLECTING SAMPLE NUMBER (00027)	GAGE HEIGHT (FEET) (00065)	DIS-CHARGE, INST. CUBIC FEET PER SECOND (00061)	NUMBER OF SAMPLING POINTS (COUNT) (00063)	BARO-METRIC PRES-SURE (MM OF HG) (00025)	OXYGEN, DIS-SOLVED (MG/L) (00300)	PH WATER WHOLE FIELD (STAND-ARD UNITS) (00400)	SPE-CIFIC CON-DUCT-ANCE (US/CM) (00095)	TEMPER-ATURE AIR (DEG C) (00020)	TEMPER-ATURE WATER (DEG C) (00010)	
OCT 1999	05...	1530	80020	81700	25.65	2460	6	746	4.9	7.4	595	19.0	17.6
NOV	02...	1525	80020	81700	25.59	1740	6	741	5.2	7.7	815	7.0	16.5
DEC	07...	1520	80020	81700	25.66	2180	3	743	6.2	7.7	589	6.5	10.9
JAN 2000	04...	1500	80020	81700	25.54	1820	6	743	10.0	7.8	898	-2.5	9.9
FEB	01...	1520	80020	81700	25.57	1780	6	750	11.4	7.3	1470	-1.0	7.0
MAR	07...	1410	80020	1028	25.58	870	3	743	4.9	7.4	1410	25.0	14.1
APR	04...	1520	80020	81700	25.78	1080	6	745	7.9	7.1	1160	7.0	15.3
	20...	1200	80020	81700	20.92	13400	6	734	5.5	7.0	974	17.0	14.7
MAY	02...	1515	80020	81700	25.64	2060	6	750	5.1	7.2	1160	23.0	18.2
JUN	08...	1600	80020	81700	25.49	2140	6	743	3.7	7.2	818	33.0	20.1
	27...	1425	80020	81700	24.20	6460	6	745	4.0	7.1	628	24.5	23.3
AUG	01...	1800	80020	81700	25.36	3340	6	743	4.1	7.1	662	31.5	25.1
SEP	06...	1235	80020	1028	25.18	5030	6	755	5.2	7.5	622	23.0	25.2

DATE	CALCIUM DIS-SOLVED (MG/L AS CA) (00915)	MAGNE-SIUM, DIS-SOLVED (MG/L AS MG) (00925)	POTAS-SIUM, DIS-SOLVED (MG/L AS K) (00935)	SODIUM, DIS-SOLVED (MG/L AS NA) (00930)	ALKA-LINITY WAT DIS TOT IT FIELD (MG/L AS CaCO ₃) (39086)	BICAR-BONATE WATER DIS IT FIELD (MG/L AS HCO ₃) (00453)	CHLO-RIDE, DIS-SOLVED (MG/L AS CL) (00940)	FLUO-RIDE, DIS-SOLVED (MG/L AS F) (00950)	SILICA, DIS-SOLVED (MG/L AS SiO ₂) (00955)	SULFATE DIS-SOLVED (MG/L AS SO ₄) (00945)	NITRO-GEN, AMMONIA DIS-SOLVED (MG/L AS N) (00608)	NITRO-GEN, AM-MONIA + ORGANIC DIS, (MG/L AS N) (00623)	
OCT 1999	05...	41.0	14.0	6.1	54.8	103	126	75.2	.6	4.2	64.8	<.020	1.2
NOV	02...	51.6	18.0	9.4	82.0	131	160	104	1.1	5.1	94.9	1.57	2.4
DEC	07...	36.3	12.6	5.6	61.3	87	106	70.3	.6	3.7	76.1	.640	1.4
JAN 2000	04...	52.2	18.8	9.6	103	130	159	138	1.1	4.7	99.1	.389	1.3
FEB	01...	59.1	20.1	9.6	232	130	158	325	1.1	5.2	110	.476	1.4
MAR	07...	69.1	26.1	7.9	172	165	201	289	.9	5.8	105	1.25	2.1
APR													

Electronic Filing - Received, Clerk's Office, March 18, 2008

05536995 DATA: Chemical and Microbiological Tables, 2000 * * * * * AS 2008-008 * * * * *

MAY	04...	64.5	23.3	10.1	129	146	178	195	1.1	5.2	116	1.95	3.0
	20...	51.6	19.5	6.9	111	125	152	174	.8	4.4	78.3	.576	1.3
	02...	71.4	27.0	7.9	124	169	206	192	.7	6.2	111	.370	1.2
JUN	08...	49.1	18.9	5.5	74.9	138	168	115	.5	4.7	73.0	.298	1.0
	27...	42.3	15.5	4.8	55.7	108	131	80.2	.5	6.2	51.7	.130	1.2
AUG	01...	43.4	15.5	5.6	66.8	118	144	86.5	.6	3.7	74.4	.380	1.1
SEP	06...	48.7	16.3	5.6	56.3	--	--	68.6	.7	3.0	66.6	.151	.73

DATE	NITRO- GEN,AM- MONIA + ORGANIC TOTAL (MG/L AS N) (00625)	NITRO- GEN DIS- SOLVED (MG/L AS N) (00602)	NITRO- GEN, NITRATE DIS- SOLVED (MG/L AS N) (00618)	NITRO- GEN, NO ₂ +NO ₃ DIS- SOLVED (MG/L AS N) (00631)	NITRO- GEN, ORGANIC DIS- SOLVED (MG/L AS N) (00607)	NITRO- GEN, ORGANIC TOTAL (MG/L AS N) (00605)	NITRO- GEN, TOTAL (MG/L AS N) (00600)	NITRO- GEN, NITRITE DIS- SOLVED (MG/L AS N) (00613)	PHOS- PHATE, ORTHO, DIS- SOLVED (MG/L AS PO ₄) (00660)	PHOS- PHORUS DIS- SOLVED (MG/L AS P) (00666)	PHOS- PHORUS ORTHO, DIS- SOLVED (MG/L AS P) (00671)	PHOS- PHORUS TOTAL (MG/L AS P) (00665)	
OCT 1999													
NOV	05...	.98	5.6	4.24	4.36	--	--	5.3	.119	2.23	.883	.726	.981
DEC	02...	2.5	10	7.54	7.82	.80	.88	10	.281	5.90	2.28	1.92	2.22
JAN 2000	07...	1.6	6.3	4.71	4.86	76	.94	6.4	.142	4.62	1.55	1.51	1.68
FEB	04...	1.4	8.4	6.89	7.11	.90	1.0	8.5	.219	3.77	1.36	1.23	1.49
MAR	01...	1.5	8.5	6.78	7.14	.90	1.0	8.6	.355	4.65	1.81	1.52	1.95
APR	07...	2.4	8.1	5.71	5.95	.89	1.2	8.4	.236	2.57	.996	.837	1.09
MAY	04...	3.1	9.9	6.66	6.99	1.0	1.2	10	.327	5.38	1.97	1.75	2.16
	20...	2.7	6.3	4.83	5.01	.72	2.1	7.7	.185	2.26	.857	.736	2.12
JUN	02...	1.3	8.1	6.80	6.91	.79	.92	8.2	.111	2.68	.954	.875	.134
AUG	08...	1.1	5.1	3.95	4.07	.70	.84	5.2	.122	1.96	.742	.638	.854
	27...	1.4	6.3	4.90	5.16	1.0	1.2	6.5	.256	1.89	.757	.615	.895
SEP	01...	1.1	6.0	4.85	4.98	.67	.71	6.1	.131	3.13	1.17	1.02	1.28
	06...	1.1	5.9	5.13	5.21	.58	.97	6.3	.080	4.86	1.66	1.59	1.78

DATE	SOLIDS, RESIDUE AT 180 DEG. C DIS- SOLVED (MG/L 70300)	IRON, DIS- SOLVED (UG/L AS FE) (01046)	MANGA- NESE, DIS- SOLVED (UG/L AS MN) (01056)	SEDI- MENT, SUS- PENDED (MG/L) (80154)	SED. SUSP. SIEVE DIAM. % FINER THAN .062 MM (70331)	PURPOSE SITE VISIT, (CODE) (50280)	QUALITY ASSUR- ANCE DATA INDICA- TOR CODE (99111)	REP- PLICATE TYPE (CODE) (99105)	SAMPLE PURPOSE CODE (71999)	SAMPLER TYPE (CODE) (84164)	SAM- PLING METHOD, CODES (82398)
OCT 1999											
05...	348	20	18	57	95	1001	1	--	15.00	3060	10

Electronic Filing - Received, Clerk's Office, March 18, 2008

05536995 DATA: Chemical and Microbiological Tables, 2000 **AS 2008-008 * * * * ***

NOV	02...	492	20	23	75	98	1001	1	--	15.00	3060	10
DEC	07...	353	40	26	62	94	1001	1	--	15.00	3060	10
JAN 2000	04...	561	40	16	77	96	1001	1	--	15.00	3060	10
FEB	01...	872	40	27	146	95	1001	1	--	15.00	3060	10
MAR	07...	842	30	38	104	98	1001	1	--	15.00	3060	10
APR	04...	684	30	50	138	97	1001	1	--	15.00	3060	10
	20...	568	36	44	257	74	1003	1	--	15.00	3052	10
MAY	02...	694	20	37	132	98	1001	1	--	15.00	3060	10
JUN	08...	472	10	27	92	95	1001	1	--	15.00	3060	10
	27...	377	30	23	47	96	1001	1	--	15.00	3060	10
AUG	01...	411	10	18	95	100	1001	10	--	15.00	3060	10
SEP	06...	363	10	13	94	95	1001	30	20.00	15.00	3052	10

[Table of Contents](#) [Introduction](#) [Station Descriptions](#) [Surface-Water Data](#) [Ground-Water Data](#) [Meteorological Data](#) [Biological Data](#)

Station list Available data

ILLINOIS RIVER BASIN

05536995 CHICAGO SANITARY AND SHIP CANAL AT ROMEOVILLE, IL

LOCATION.-- Lat 41°38'27", long 88°03'35", in SE1/4SW1/4 sec.35, T.37 N., R.10 E., Will County, Hydrologic Unit 07120004, on left bank 40 ft upstream from bridge on Romeoville Road in Romeoville, 5.2 mi upstream from Lockport Lock and Dam, and at mile 6.2.

DRAINAGE AREA.-- 739 mi².

PERIOD OF RECORD.--

SURFACE-WATER DISCHARGE AND STAGE

DISCHARGE: October 1984 to current year.

STAGE: Water years 1994-2001.

SURFACE-WATER QUALITY

CHEMICAL: Water years 1987-92 and 1999 to current.

WATER TEMPERATURE: Water years 1974-77.

REVISED RECORDS.-- WDR IL-86-2: 1985. WDR IL-89-2: 1986. WDR IL-92-2: 1986-89.

GAGE.-- Acoustical flowmeter and phone telemeter. Datum of gage is 551.89 ft above sea level (U.S. Army Corps of Engineers bench mark).

REMARKS.-- Estimated daily discharges determined from a regression relation between present site and the previous site 5.2 mi downstream. This gaging station provides flow data essential to determine Illinois' diversion of Lake Michigan water. A U.S. Supreme Court Decree limits Illinois' diversion to an average of 3,200 ft³/s. Illinois' diversion includes water diverted from the lake for domestic water supply, for navigation and water-quality improvement in the Chicago Sanitary and Ship Canal system, and the stormwater runoff from a 673 mi² diverted watershed area. Flows recorded at this station also include nondiversion flows.

EXTREMES FOR PERIOD RECORD.--

SURFACE-WATER DISCHARGE AND STAGE: Maximum discharge, 19,466 ft³/s, Feb. 21, 1997, gage-height, 23.95 ft; maximum gage-height, 26.43 ft, Feb. 4, 1996, discharge, 2,876 ft³/s; minimum discharge, no flow or periods of reverse flow at times in most years.

REMARKS FOR CURRENT YEAR.-- Sampled as part of the Upper Illinois River Basin (UIRB) National Water Quality Assessment Program (NAWQA).

		SURFACE-WATER QUALITY											
DATE	TIME	AGENCY ANA-LYZING SAMPLE (CODE NUMBER) (00028)	AGENCY COLLECTING SAMPLE (CODE NUMBER) (00027)	GAGE HEIGHT (FEET) (00065)	DIS-CHARGE, INST. CUBIC FEET PER SECOND (00061)	OXYGEN, DIS-SOLVED (MG/L) (00300)	OXYGEN, DIS-SOLVED (PER-CENT SATURATION) (00301)	PH WATER WHOLE FIELD (STANDARD UNITS) (00400)	SPE-CIFIC CON-DUCTANCE (US/CM) (00095)	TEMPER-ATURE AIR (DEG C) (00020)	TEMPER-ATURE WATER (DEG C) (00010)	CALCIUM DIS-SOLVED (MG/L AS CA) (00915)	MAGNE-SIUM, DIS-SOLVED (MG/L AS MG) (00925)
OCT 2000	02...	80020	81700	25.28	2660	-	-	7.6	705	28.0	20.4	54.7	18.3
NOV 2000	08...	80020	81700	25.59	1340	6.4	68.2	7.3	845	8.0	17.1	52.8	19.0
DEC 2000	04...	80020	81700	24.66	2450	8.0	71.7	7.4	917	2.5	10	58.4	20.8
JAN 2001	04...	80020	81700	24.59	3960	7.3	61.1	7.2	2770	-2.0	6.2	65.6	22.5
FEB 2001	21...	80020	81700	25.36	1770	9.0	74.2	7.5	1470	-3.0	6.5	77.6	30.7

DATE	POTAS-SIUM, DIS-SOLVED (MG/L AS K) (00935)	SODIUM, DIS-SOLVED (MG/L AS NA) (00930)	ALKA-LINITY WAT DIS TOT IT FIELD (MG/L AS CACO ₃) (39086)	BICAR-BONATE WATER DIS IT FIELD (MG/L AS HCO ₃) (00453)	CHLO-RIDE, DIS-SOLVED (MG/L AS CL) (00940)	FLUO-RIDE, DIS-SOLVED (MG/L AS F) (00950)	SILICA, DIS-SOLVED (MG/L AS SIO ₂) (00955)	SULFATE DIS-SOLVED (MG/L AS SO ₄) (00945)	SOLIDS, RESIDUE AT 180 DEG. C DIS-SOLVED (MG/L) (70300)	NITRO-GEN, AMMONIA DIS-SOLVED (MG/L AS N) (00608)	NITRO-GEN,AM-MONIA + ORGANIC DIS. (MG/L AS N) (00623)	NITRO-GEN,AM-MONIA + ORGANIC TOTAL (MG/L AS N) (00625)	NITRO-GEN, NO ₂ +NO ₃ DIS-SOLVED (MG/L AS N) (00631)
OCT 2000	5.64	67.1	130	159	84.2	.6	4.8	66.6	412	.212	.77	.88	4.54
NOV 2000	8.23	89.1	122	149	108	1.0	4.9	98.8	518	.237	.94	1.2	8.14
DEC 2000	7.27	93.3	140	171	127	1.0	5.4	97.1	547	.566	.36	1.9	7.16
JAN 2001	9.71	461	158	193	713	1.1	5.3	110	1580	2.57	3.6	3.8	4.42
FEB 2001	6.94	174	171	209	283	.7	6.8	105	860	.890	1.7	1.8	5.34

DATE	NITRO-GEN, NITRITE DIS-SOLVED (MG/L AS N) (00613)	PHOS-PHORUS DIS-SOLVED (MG/L AS P) (00666)	PHOS-PHORUS ORTHO, DIS-SOLVED (MG/L AS P) (00671)	PHOS-PHORUS TOTAL (MG/L AS P) (00665)	IRON, DIS-SOLVED (UG/L AS FE) (01046)	MANGA-NESE, DIS-SOLVED (UG/L AS MN) (01056)	SED. SUSP. SIEVE DIAM. % FINER THAN .062 MM (70331)	SEDI-MENT, SUS-PENDED (MG/L) (80154)
OCT 2000	.068	-	.957	1.08	10	17.7	98	76
NOV 2000	.116	2.12	2.26	2.54	20	19.5	92	95
DEC 2000	.247	<.060	1.23	1.51	30	22.5	100	92
JAN 2001	.538	1.65	1.50	1.74	50	49.6	99	207

FIGURE 17: DISSOLVED OXYGEN CONCENTRATION MEASURED HOURLY
AT ROUTE 83 ON THE CHICAGO SANITARY & SHIP CANAL
FROM JANUARY 2002 THROUGH DECEMBER 2002

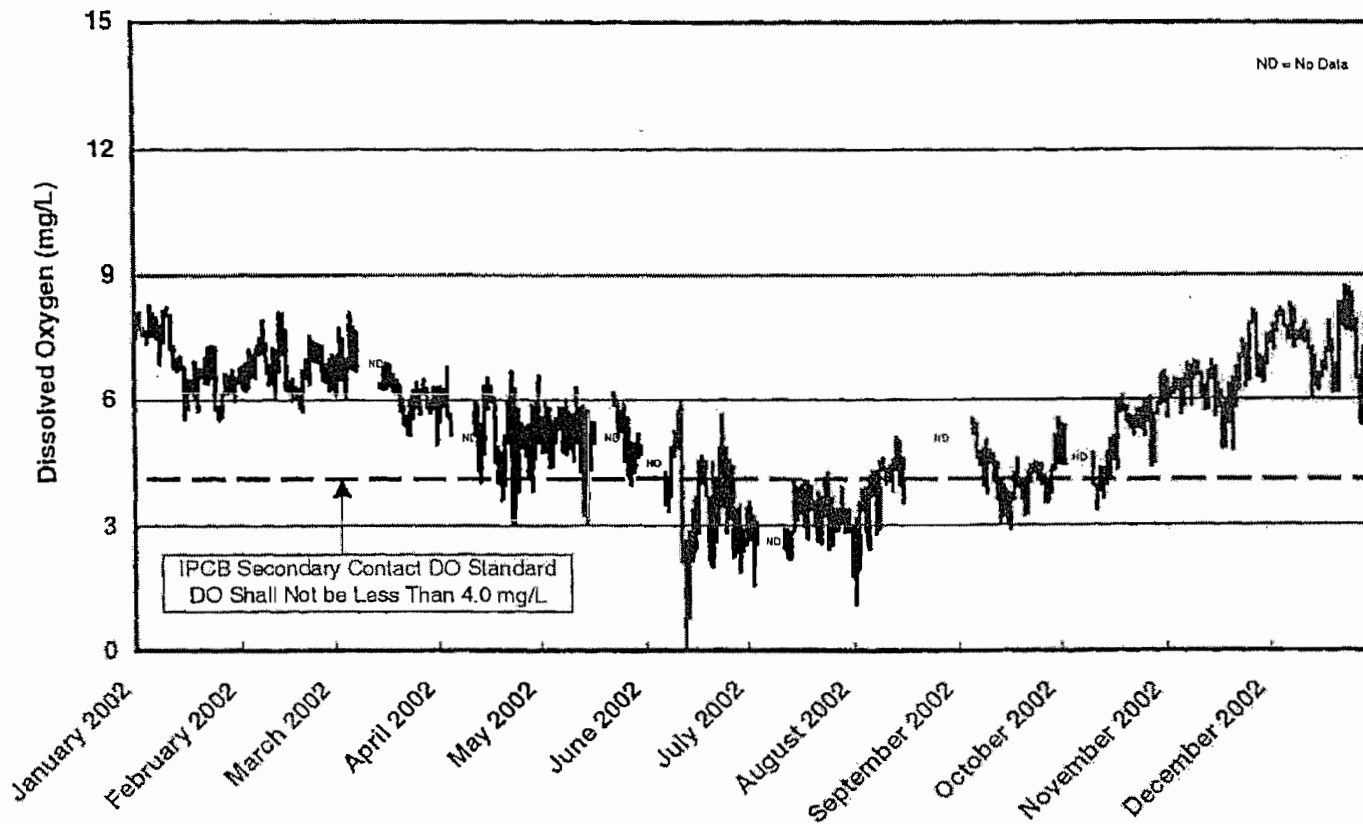

FIGURE 20: DISSOLVED OXYGEN CONCENTRATION MEASURED HOURLY AT LOCKPORT POWERHOUSE ON THE CHICAGO SANITARY & SHIP CANAL FROM JANUARY 2002 THROUGH DECEMBER 2002

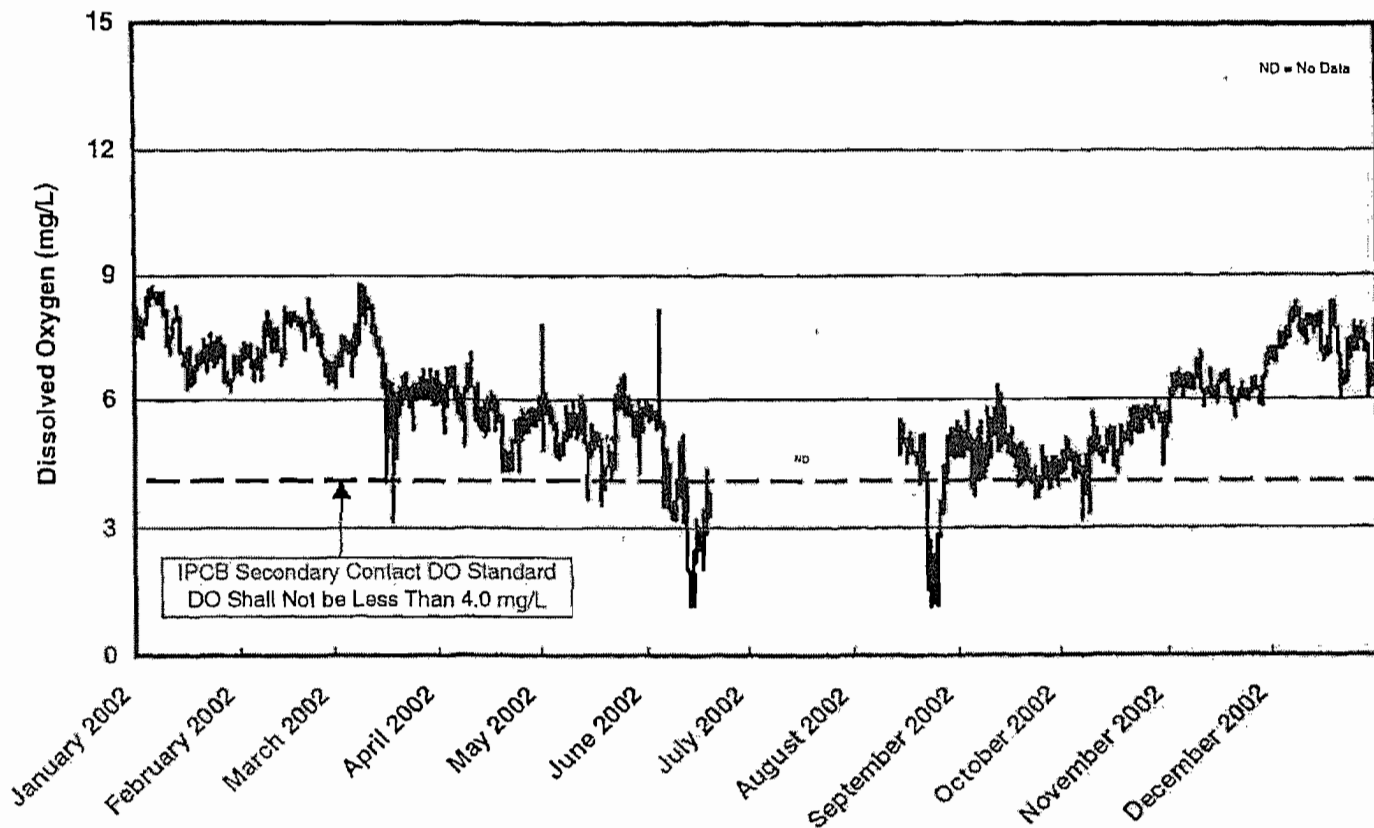

FIGURE 21: DISSOLVED OXYGEN CONCENTRATION MEASURED HOURLY
AT JEFFERSON STREET ON THE DES PLAINES RIVER
FROM JANUARY 2002 THROUGH DECEMBER 2002

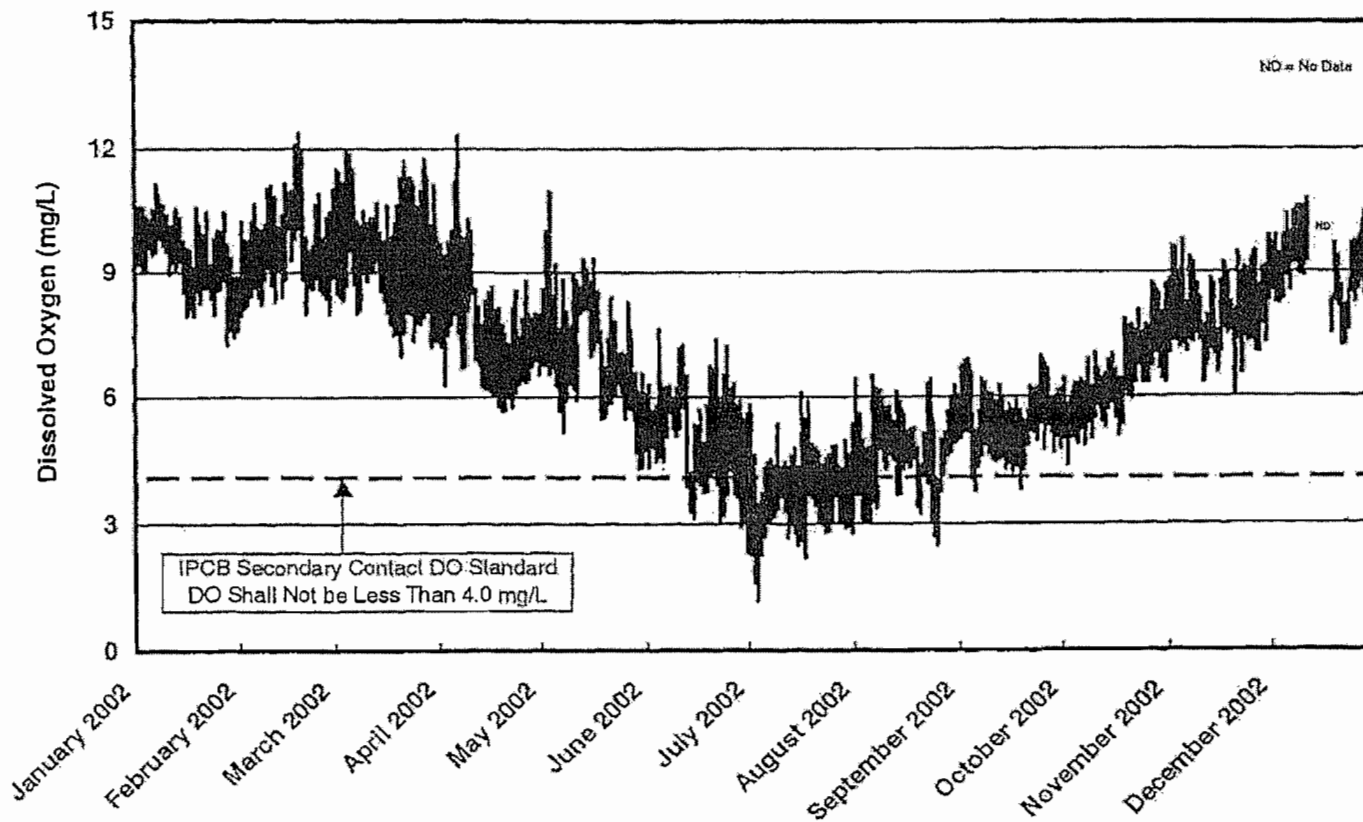

TABLE AI-16: WEEKLY DO SUMMARY STATISTICS AT ROUTE 83 ON THE CHICAGO SANITARY AND SHIP CANAL FROM JANUARY 2002 THROUGH DECEMBER 2002

Monitoring Dates	Number of DO Values	DO Concentration (mg/L)			Percent DO Values Above Standard
		Min	Max	Mean	
01/01/02 - 01/06/02	144	7.4	8.3	7.8	100
01/07/02 - 01/13/02	168	6.7	8.2	7.5	100
01/14/02 - 01/20/02	167	5.5	7.0	6.4	100
01/21/02 - 01/27/02	168	5.5	7.3	6.4	100
01/28/02 - 02/03/02	168	6.0	7.2	6.5	100
02/04/02 - 02/10/02	168	6.4	7.9	7.0	100
02/11/02 - 02/17/02	168	6.0	8.1	6.7	100
02/18/02 - 02/24/02	168	5.7	7.5	6.8	100
02/25/02 - 03/03/02	168	6.1	7.7	6.8	100
03/04/02 - 03/10/02	82	6.0	8.1	7.0	100
03/11/02 - 03/17/02	81	6.3	6.9	6.5	100
03/18/02 - 03/24/02	168	5.1	6.6	5.9	100
03/25/02 - 03/31/02	168	4.9	6.5	5.9	100
04/01/02 - 04/07/02	82	5.1	6.8	6.0	100
04/08/02 - 04/14/02	86	4.0	6.3	5.5	100
04/15/02 - 04/21/02	168	3.6	6.5	5.1	94
04/22/02 - 04/28/02	168	3.0	6.7	5.1	93
04/29/02 - 05/05/02	168	4.4	6.6	5.3	100
05/06/02 - 05/12/02	168	4.3	6.3	5.3	100
05/13/02 - 05/19/02	85	3.1	5.9	4.5	67
05/20/02 - 05/26/02	109	4.2	6.2	5.4	100
05/27/02 - 06/02/02	83	4.0	5.1	4.7	96
06/03/02 - 06/09/02	85	3.3	5.3	4.3	59
06/10/02 - 06/16/02	168	0.1	5.9	3.2	26
06/17/02 - 06/23/02	168	2.0	5.6	3.7	42
06/24/02 - 06/30/02	168	1.9	4.8	3.2	17
07/01/02 - 07/07/02	59	1.6	3.5	3.0	0
07/08/02 - 07/14/02	83	2.2	4.0	2.8	1
07/15/02 - 07/21/02	168	2.6	4.0	3.4	2
07/22/02 - 07/28/02	168	2.4	4.2	3.3	5
07/29/02 - 08/04/02	168	1.1	3.9	3.0	0
08/05/02 - 08/11/02	168	2.4	4.6	4.0	61
08/12/02 - 08/18/02	90	3.5	5.1	4.4	76
08/19/02 - 08/25/02			NO DATA		
08/26/02 - 09/01/02			NO DATA		
09/02/02 - 09/08/02	85	3.9	5.5	4.8	99
09/09/02 - 09/15/02	168	3.1	5.0	4.0	52
09/16/02 - 09/22/02	168	2.9	4.6	3.9	35
09/23/02 - 09/29/02	168	3.5	5.1	4.2	70
09/30/02 - 10/06/02	55	4.4	5.5	5.0	100
10/07/02 - 10/13/02	83	3.4	4.7	4.0	43
10/14/02 - 10/20/02	168	4.0	6.1	5.1	99
10/21/02 - 10/27/02	168	4.4	6.0	5.5	100
10/28/02 - 11/03/02	168	4.5	6.7	6.0	100
11/04/02 - 11/10/02	168	5.7	6.9	6.4	100
11/11/02 - 11/17/02	168	4.8	6.9	6.2	100
11/18/02 - 11/24/02	168	4.8	7.4	6.3	100
11/25/02 - 12/01/02	168	6.4	8.1	7.2	100

TABLE AI-16 (Continued): WEEKLY DO SUMMARY STATISTICS AT ROUTE 83 ON THE CHICAGO
SANITARY AND SHIP CANAL FROM JANUARY 2002 THROUGH DECEMBER 2002

Monitoring Dates	Number of DO Values	DO Concentration (mg/L)			Percent DO Values Above Standard
		Min	Max	Mean	
12/02/02 - 12/08/02	168	7.2	8.3	7.8	100
12/09/02 - 12/15/02	168	6.1	7.8	7.1	100
12/16/02 - 12/22/02	168	6.2	8.3	7.1	100
12/23/02 - 12/29/02	168	5.4	8.7	7.4	100
12/30/02 - 12/31/02	48	6.6	7.8	7.2	100

TABLE AI-19: WEEKLY DO SUMMARY STATISTICS AT LOCKPORT POWERHOUSE ON THE CHICAGO
SANITARY AND SHIP CANAL FROM JANUARY 2002 THROUGH DECEMBER 2002

Monitoring Dates	Number of DO Values	DO Concentration (mg/L)			Percent DO Values Above Standard
		Min	Max	Mean	
01/01/02 - 01/06/02	144	7.5	8.7	8.1	100
01/07/02 - 01/13/02	168	7.1	8.6	8.0	100
01/14/02 - 01/20/02	167	6.3	8.0	6.9	100
01/21/02 - 01/27/02	168	6.4	7.6	7.1	100
01/28/02 - 02/03/02	165	6.2	7.4	6.8	100
02/04/02 - 02/10/02	168	6.5	8.1	7.2	100
02/11/02 - 02/17/02	168	6.8	8.2	7.7	100
02/18/02 - 02/24/02	168	7.2	8.4	7.8	100
02/25/02 - 03/03/02	168	6.3	7.6	6.9	100
03/04/02 - 03/10/02	168	6.6	8.8	7.7	100
03/11/02 - 03/17/02	168	4.1	8.4	7.2	100
03/18/02 - 03/24/02	168	3.1	6.6	6.0	99
03/25/02 - 03/31/02	168	5.9	6.7	6.3	100
04/01/02 - 04/07/02	168	5.2	6.8	6.1	100
04/08/02 - 04/14/02	166	4.9	7.1	5.9	100
04/15/02 - 04/21/02	168	4.3	6.2	5.3	100
04/22/02 - 04/28/02	168	4.3	5.8	5.3	100
04/29/02 - 05/05/02	168	4.7	7.8	5.7	100
05/06/02 - 05/12/02	168	4.6	6.1	5.4	100
05/13/02 - 05/19/02	168	3.5	5.9	4.8	90
05/20/02 - 05/26/02	168	4.2	6.6	5.5	100
05/27/02 - 06/02/02	168	4.3	6.0	5.5	100
06/03/02 - 06/09/02	168	3.2	8.2	4.4	51
06/10/02 - 06/16/02	165	1.2	5.1	3.0	25
06/17/02 - 06/23/02	59	2.0	4.3	3.2	14
06/24/02 - 06/30/02			NO DATA		
07/01/02 - 07/07/02			NO DATA		
07/08/02 - 07/14/02			NO DATA		
07/15/02 - 07/21/02			NO DATA		
07/22/02 - 07/28/02			NO DATA		
07/29/02 - 08/04/02			NO DATA		
08/05/02 - 08/11/02			NO DATA		
08/12/02 - 08/18/02	109	4.5	5.5	5.0	100
08/19/02 - 08/25/02	168	1.2	5.2	3.2	49
08/26/02 - 09/01/02	168	2.8	5.5	4.5	77
09/02/02 - 09/08/02	168	3.7	5.7	4.7	94
09/09/02 - 09/15/02	168	4.5	6.3	5.2	100
09/16/02 - 09/22/02	168	4.0	5.3	4.5	99
09/23/02 - 09/29/02	168	3.7	4.8	4.2	72
09/30/02 - 10/06/02	168	4.0	5.1	4.5	99
10/07/02 - 10/13/02	168	3.2	5.7	4.6	84
10/14/02 - 10/20/02	167	4.3	5.4	4.9	100
10/21/02 - 10/27/02	167	4.9	5.8	5.5	100
10/28/02 - 11/03/02	168	4.4	6.6	5.8	100
11/04/02 - 11/10/02	168	6.1	7.1	6.5	100
11/11/02 - 11/17/02	168	5.8	6.7	6.3	100
11/18/02 - 11/24/02	168	5.6	6.7	6.1	100
11/25/02 - 12/01/02	168	5.8	7.2	6.6	100

TABLE AI-19 (Continued): WEEKLY DO SUMMARY STATISTICS AT LOCKPORT POWERHOUSE ON THE CHICAGO SANITARY AND SHIP CANAL FROM JANUARY 2002 THROUGH DECEMBER 2002

Monitoring Dates	Number of DO Values	DO Concentration (mg/L)			Percent DO Values Above Standard
		Min	Max	Mean	
12/02/02 - 12/08/02	168	6.9	8.3	7.6	100
12/09/02 - 12/15/02	168	7.2	8.2	7.8	100
12/16/02 - 12/22/02	168	6.0	8.3	7.2	100
12/23/02 - 12/29/02	168	6.1	7.8	7.3	100
12/30/02 - 12/31/02	48	6.3	7.9	6.9	100

TABLE AI-20: WEEKLY DO SUMMARY STATISTICS AT JEFFERSON STREET ON THE DES PLAINES RIVER FROM JANUARY 2002 THROUGH DECEMBER 2002

Monitoring Dates	Number of DO Values	DO Concentration (mg/L)			Percent DO Values Above Standard
		Min	Max	Mean	
01/01/02 - 01/06/02	144	9.0	10.6	9.8	100
01/07/02 - 01/13/02	168	8.9	11.1	9.9	100
01/14/02 - 01/20/02	168	8.0	10.6	8.9	100
01/21/02 - 01/27/02	168	8.0	10.5	9.0	100
01/28/02 - 02/03/02	168	7.3	10.2	8.5	100
02/04/02 - 02/10/02	168	8.2	11.1	9.3	100
02/11/02 - 02/17/02	168	8.3	12.1	9.9	100
02/18/02 - 02/24/02	168	8.0	12.3	9.5	100
02/25/02 - 03/03/02	168	8.0	11.5	9.3	100
03/04/02 - 03/10/02	168	8.0	12.0	9.8	100
03/11/02 - 03/17/02	168	7.7	10.7	9.3	100
03/18/02 - 03/24/02	168	7.0	11.7	8.8	100
03/25/02 - 03/31/02	168	7.2	11.7	8.9	100
04/01/02 - 04/07/02	168	6.3	12.3	8.6	100
04/08/02 - 04/14/02	167	6.2	10.3	8.1	100
04/15/02 - 04/21/02	168	5.7	8.6	6.8	100
04/22/02 - 04/28/02	168	5.8	8.8	7.1	100
04/29/02 - 05/05/02	168	6.3	10.9	7.5	100
05/06/02 - 05/12/02	168	5.2	8.9	7.2	100
05/13/02 - 05/19/02	168	5.5	9.3	7.6	100
05/20/02 - 05/26/02	168	5.5	8.4	6.6	100
05/27/02 - 06/02/02	167	4.3	7.4	5.4	100
06/03/02 - 06/09/02	167	4.5	7.6	5.6	100
06/10/02 - 06/16/02	168	3.1	7.3	4.9	77
06/17/02 - 06/23/02	168	3.0	7.4	4.8	83
06/24/02 - 06/30/02	168	2.3	7.2	4.5	70
07/01/02 - 07/07/02	167	1.2	5.8	3.2	22
07/08/02 - 07/14/02	168	2.7	5.3	3.8	36
07/15/02 - 07/21/02	168	2.2	6.1	4.0	49
07/22/02 - 07/28/02	167	2.8	4.8	3.7	30
07/29/02 - 08/04/02	168	2.8	6.4	4.1	50
08/05/02 - 08/11/02	167	3.0	6.5	4.9	83
08/12/02 - 08/18/02	168	3.7	6.1	4.9	97
08/19/02 - 08/25/02	168	2.5	6.4	4.3	60
08/26/02 - 09/01/02	168	3.8	6.7	5.2	98
09/02/02 - 09/08/02	168	3.8	6.9	5.3	96
09/09/02 - 09/15/02	168	4.3	6.3	5.2	100
09/16/02 - 09/22/02	167	3.8	6.3	5.1	98
09/23/02 - 09/29/02	166	4.7	7.0	5.7	100
09/30/02 - 10/06/02	168	4.4	6.4	5.5	100
10/07/02 - 10/13/02	168	4.8	7.0	5.9	100
10/14/02 - 10/20/02	168	5.1	7.8	6.1	100
10/21/02 - 10/27/02	168	6.0	8.7	6.9	100
10/28/02 - 11/03/02	168	6.4	9.6	7.6	100
11/04/02 - 11/10/02	168	7.1	9.8	7.8	100
11/11/02 - 11/17/02	168	6.4	9.2	7.4	100
11/18/02 - 11/24/02	168	6.1	9.5	7.7	100
11/25/02 - 12/01/02	167	7.1	9.9	8.2	100

TABLE AI-20 (Continued): WEEKLY DO SUMMARY STATISTICS AT JEFFERSON STREET ON THE DES PLAINES RIVER FROM JANUARY 2002 THROUGH DECEMBER 2002

Monitoring Dates	Number of DO Values	DO Concentration (mg/L)			Percent DO Values Above Standard
		Min	Max	Mean	
12/02/02 - 12/08/02	167	8.3	10.6	9.2	100
12/09/02 - 12/15/02	59	8.9	10.8	9.5	100
12/16/02 - 12/22/02	108	7.2	9.7	8.3	100
12/23/02 - 12/29/02	168	7.6	10.4	8.9	100
12/30/02 - 12/31/02	48	7.5	9.3	8.4	100

FIGURE 18: DISSOLVED OXYGEN CONCENTRATION MEASURED HOURLY
AT ROUTE 83 ON THE CHICAGO SANITARY AND SHIP CANAL
FROM JANUARY 2003 THROUGH DECEMBER 2003

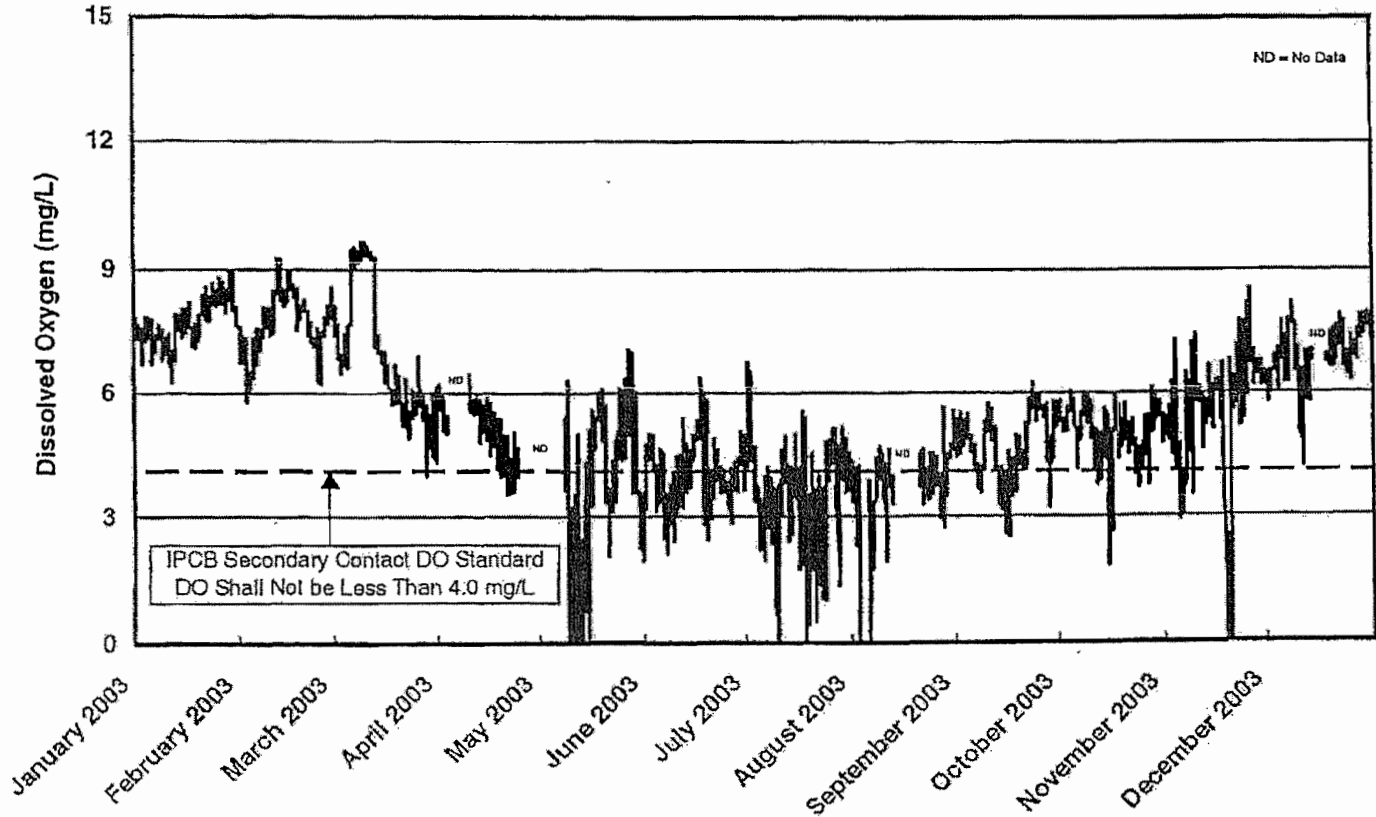

FIGURE 21: DISSOLVED OXYGEN CONCENTRATION MEASURED HOURLY AT LOCKPORT POWERHOUSE ON THE CHICAGO SANITARY AND SHIP CANAL FROM JANUARY 2003 THROUGH DECEMBER 2003

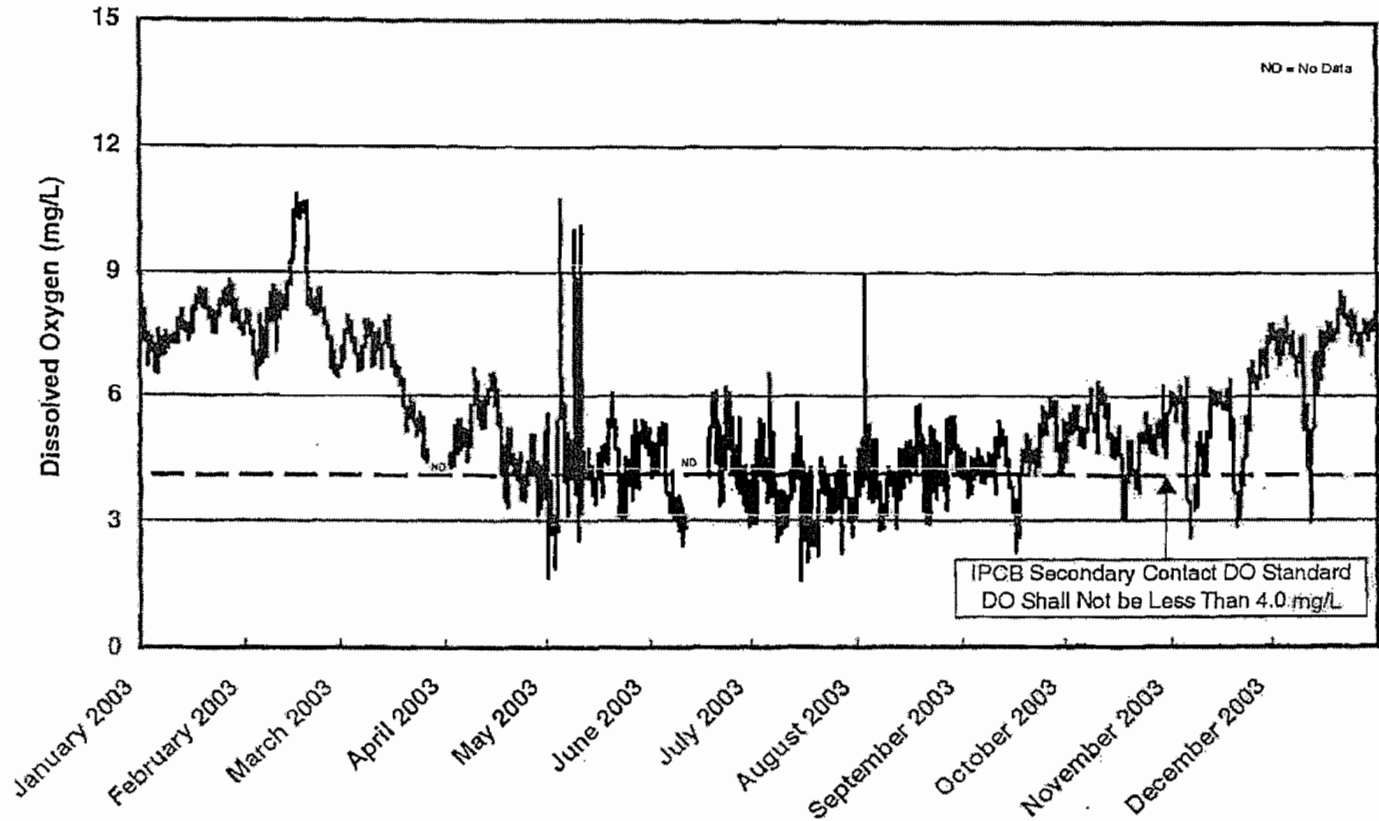

FIGURE 22: DISSOLVED OXYGEN CONCENTRATION MEASURED HOURLY
AT JEFFERSON STREET ON THE DES PLAINES RIVER
FROM JANUARY 2003 THROUGH DECEMBER 2003

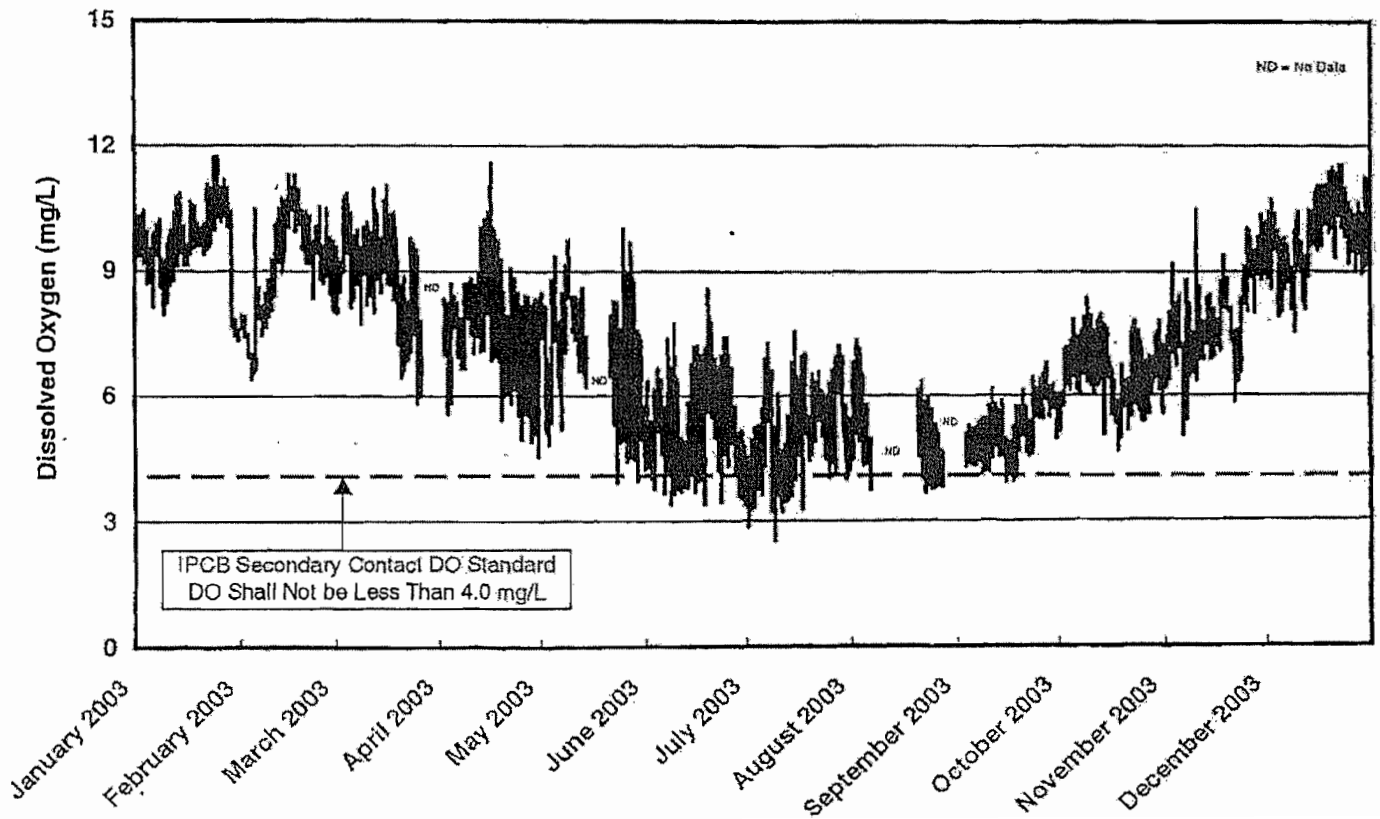

TABLE AI-17: WEEKLY DO SUMMARY STATISTICS AT ROUTE 83 ON THE CHICAGO SANITARY AND SHIP CANAL DURING 2003

Monitoring Dates	Number of DO Values	DO Concentration (mg/L)			Percent DO Values Above Standard
		Min	Max	Mean	
01/01/03 - 01/05/03	120	6.7	7.9	7.5	100
01/06/03 - 01/12/03	168	6.3	7.8	7.1	100
01/13/03 - 01/19/03	168	6.8	8.2	7.6	100
01/20/03 - 01/26/03	168	7.3	8.8	8.2	100
01/27/03 - 02/02/03	168	6.7	9.0	8.0	100
02/03/03 - 02/09/03	168	5.8	8.1	7.1	100
02/10/03 - 02/16/03	168	7.4	9.2	8.4	100
02/17/03 - 02/23/03	167	7.1	8.6	7.9	100
02/24/03 - 03/02/03	168	6.2	8.6	7.5	100
03/03/03 - 03/09/03	167	6.5	9.6	8.2	100
03/10/03 - 03/16/03	168	6.3	9.6	8.2	100
03/17/03 - 03/23/03	144	4.9	6.7	5.9	100
03/24/03 - 03/30/03	168	4.0	6.9	5.5	99
03/31/03 - 04/06/03	82	4.3	6.2	5.5	100
04/07/03 - 04/13/03	85	4.8	6.5	5.6	100
04/14/03 - 04/20/03	168	3.9	5.9	5.1	99
04/21/03 - 04/27/03	82	3.5	5.0	4.1	54
04/28/03 - 05/04/03			NO DATA		
05/05/03 - 05/11/03	81	0.0	6.3	1.4	19
05/12/03 - 05/18/03	168	0.0	6.0	3.1	48
05/19/03 - 05/25/03	168	2.1	6.1	4.4	63
05/26/03 - 06/01/03	168	2.0	7.1	4.6	60
06/02/03 - 06/08/03	167	2.1	5.0	3.8	40
06/09/03 - 06/15/03	168	2.4	5.4	4.1	58
06/16/03 - 06/22/03	168	2.5	6.4	4.7	80
06/23/03 - 06/29/03	168	2.8	5.1	4.0	43
06/30/03 - 07/06/03	168	2.0	6.7	3.9	45
07/07/03 - 07/13/03	168	0.0	4.9	3.3	25
07/14/03 - 07/20/03	168	0.1	5.5	3.1	28
07/21/03 - 07/27/03	168	0.5	5.1	3.5	49
07/28/03 - 08/03/03	168	0.0	5.2	3.8	52
08/04/03 - 08/10/03	168	0.0	4.7	2.4	32
08/11/03 - 08/17/03	59	1.9	4.6	3.8	36
08/18/03 - 08/24/03	79	3.3	4.6	3.9	38
08/25/03 - 08/31/03	159	2.7	5.6	4.2	61
09/01/03 - 09/07/03	167	3.7	5.5	4.8	96
09/08/03 - 09/14/03	168	3.2	5.7	4.5	64
09/15/03 - 09/21/03	168	2.5	5.2	4.2	70
09/22/03 - 09/28/03	168	3.2	6.2	5.5	95
09/29/03 - 10/05/03	168	4.4	6.0	5.5	100
10/06/03 - 10/12/03	168	3.8	6.0	5.1	99
10/13/03 - 10/19/03	169	1.8	5.9	4.6	80
10/20/03 - 10/26/03	167	3.7	5.7	4.7	92
10/27/03 - 11/02/03	168	3.7	6.1	5.3	97
11/03/03 - 11/09/03	168	2.9	7.3	4.8	72
11/10/03 - 11/16/03	168	4.6	7.4	5.9	100
11/17/03 - 11/23/03	168	0.0	7.8	4.8	80
11/24/03 - 11/30/03	168	5.4	8.5	6.8	100
12/01/03 - 12/07/03	168	5.8	7.8	6.7	100
12/08/03 - 12/14/03	151	4.2	8.2	6.6	100
12/15/03 - 12/21/03	85	6.6	7.6	7.1	100
12/22/03 - 12/28/03	168	6.3	7.9	7.2	100
12/29/03 - 12/31/03	72	7.4	8.0	7.7	100

TABLE AI-20: WEEKLY DO SUMMARY STATISTICS AT LOCKPORT POWERHOUSE ON THE CHICAGO SANITARY AND SHIP CANAL DURING 2003

Monitoring Dates	Number of DO Values	DO Concentration (mg/L)			Percent DO Values Above Standard
		Min	Max	Mean	
01/01/03 - 01/05/03	120	6.6	8.4	7.4	100
01/06/03 - 01/12/03	168	6.5	7.9	7.3	100
01/13/03 - 01/19/03	168	7.3	8.6	8.0	100
01/20/03 - 01/26/03	168	7.5	8.6	8.1	100
01/27/03 - 02/02/03	168	7.5	8.8	8.0	100
02/03/03 - 02/09/03	168	6.4	8.7	7.5	100
02/10/03 - 02/16/03	167	7.1	10.8	8.9	100
02/17/03 - 02/23/03	168	8.0	10.7	9.1	100
02/24/03 - 03/02/03	168	6.5	8.1	7.2	100
03/03/03 - 03/09/03	168	6.6	8.0	7.3	100
03/10/03 - 03/16/03	168	6.7	7.9	7.2	100
03/17/03 - 03/23/03	168	5.1	6.8	5.9	100
03/24/03 - 03/30/03	58	4.4	5.6	5.0	100
03/31/03 - 04/06/03	109	4.3	5.4	4.9	100
04/07/03 - 04/13/03	167	4.4	6.7	5.6	100
04/14/03 - 04/20/03	168	3.3	6.6	5.2	92
04/21/03 - 04/27/03	168	3.5	5.1	4.2	79
04/28/03 - 05/04/03	168	1.7	5.6	3.6	33
05/05/03 - 05/11/03	166	2.5	10.7	5.5	70
05/12/03 - 05/18/03	168	3.4	4.8	4.2	73
05/19/03 - 05/25/03	168	3.0	6.1	4.3	62
05/26/03 - 06/01/03	168	3.5	5.4	4.7	90
06/02/03 - 06/08/03	168	3.1	5.3	4.1	55
06/09/03 - 06/15/03	58	2.4	3.6	3.1	0
06/16/03 - 06/22/03	109	3.4	6.1	4.8	79
06/23/03 - 06/29/03	168	3.2	6.2	4.5	70
06/30/03 - 07/06/03	168	2.9	6.6	4.1	51
07/07/03 - 07/13/03	168	2.5	5.1	3.6	25
07/14/03 - 07/20/03	160	1.6	5.8	3.5	41
07/21/03 - 07/27/03	168	2.2	4.5	3.6	20
07/28/03 - 08/03/03	167	2.6	8.9	3.9	47
08/04/03 - 08/10/03	168	2.7	5.3	3.8	33
08/11/03 - 08/17/03	168	2.8	4.9	4.2	68
08/18/03 - 08/24/03	168	2.9	5.8	4.3	67
08/25/03 - 08/31/03	168	3.3	5.5	4.5	82
09/01/03 - 09/07/03	168	3.6	4.7	4.2	77
09/08/03 - 09/14/03	168	3.6	5.4	4.5	93
09/15/03 - 09/21/03	168	2.2	5.0	4.0	58
09/22/03 - 09/28/03	167	4.1	5.9	5.3	100
09/29/03 - 10/05/03	167	4.1	5.7	5.1	100
10/06/03 - 10/12/03	168	4.6	6.3	5.6	100
10/13/03 - 10/19/03	167	3.0	5.8	4.5	73
10/20/03 - 10/26/03	168	3.7	5.6	4.7	85
10/27/03 - 11/02/03	168	4.5	6.2	5.4	100
11/03/03 - 11/09/03	168	2.6	6.5	4.5	61
11/10/03 - 11/16/03	168	4.1	6.2	5.5	100
11/17/03 - 11/23/03	168	2.9	6.4	4.7	71
11/24/03 - 11/30/03	168	5.2	7.7	6.7	100
12/01/03 - 12/07/03	168	6.8	7.9	7.4	100
12/08/03 - 12/14/03	168	2.9	7.5	6.0	92
12/15/03 - 12/21/03	168	6.4	8.5	7.5	100
12/22/03 - 12/28/03	168	7.0	8.4	7.7	100
12/29/03 - 12/31/03	72	7.4	8.0	7.7	100

TABLE AI-21: WEEKLY DO SUMMARY STATISTICS AT JEFFERSON STREET ON THE
DES PLAINES RIVER DURING 2003

Monitoring Dates	Number of DO Values	DO Concentration (mg/L)			Percent DO Values Above Standard
		Min	Max	Mean	
01/01/03 – 01/05/03	120	8.7	10.4	9.5	100
01/06/03 – 01/12/03	168	8.0	10.4	9.1	100
01/13/03 – 01/19/03	168	9.1	10.8	9.8	100
01/20/03 – 01/26/03	168	9.4	11.7	10.3	100
01/27/03 – 02/02/03	168	7.4	11.2	8.7	100
02/03/03 – 02/09/03	168	6.4	10.5	7.8	100
02/10/03 – 02/16/03	168	8.1	11.3	9.7	100
02/17/03 – 02/23/03	168	8.4	11.3	9.9	100
02/24/03 – 03/02/03	168	8.0	10.5	9.0	100
03/03/03 – 03/09/03	168	7.8	10.8	9.2	100
03/10/03 – 03/16/03	168	8.0	11.0	9.3	100
03/17/03 – 03/23/03	168	6.5	10.4	8.2	100
03/24/03 – 03/30/03	59	5.8	9.6	7.7	100
03/31/03 – 04/06/03	109	5.6	8.7	7.5	100
04/07/03 – 04/13/03	167	6.7	10.0	7.9	100
04/14/03 – 04/20/03	168	5.4	11.6	8.1	100
04/21/03 – 04/27/03	168	5.0	9.1	6.8	100
04/28/03 – 05/04/03	167	4.5	8.8	6.8	100
05/05/03 – 05/11/03	168	5.2	9.7	8.0	100
05/12/03 – 05/18/03	60	6.2	8.6	7.3	100
05/19/03 – 05/25/03	109	3.9	10.0	6.4	99
05/26/03 – 06/01/03	168	4.0	9.7	5.7	99
06/02/03 – 06/08/03	168	3.4	7.4	4.9	87
06/09/03 – 06/15/03	168	3.6	7.8	4.8	83
06/16/03 – 06/22/03	168	3.4	8.6	5.8	95
06/23/03 – 06/29/03	168	3.4	7.4	5.1	92
06/30/03 – 07/06/03	168	2.9	6.9	4.4	64
07/07/03 – 07/13/03	168	2.5	7.3	4.8	73
07/14/03 – 07/20/03	168	3.3	7.6	5.4	90
07/21/03 – 07/27/03	168	4.0	6.9	5.5	100
07/28/03 – 08/03/03	168	4.0	7.4	5.8	100
08/04/03 – 08/10/03	59	3.8	6.5	5.1	97
08/11/03 – 08/17/03			NO DATA		
08/18/03 – 08/24/03	108	3.7	6.4	4.9	91
08/25/03 – 08/31/03	58	3.8	5.3	4.5	78
09/01/03 – 09/07/03	109	4.3	5.4	4.8	100
09/08/03 – 09/14/03	168	4.1	6.2	5.1	100
09/15/03 – 09/21/03	168	3.9	6.1	4.9	98
09/22/03 – 09/28/03	168	4.6	6.8	5.7	100
09/29/03 – 10/05/03	167	5.0	7.8	6.2	100
10/06/03 – 10/12/03	168	6.0	8.4	6.8	100
10/13/03 – 10/19/03	168	4.7	8.0	6.1	100
10/20/03 – 10/26/03	167	5.2	7.8	6.1	100
10/27/03 – 11/02/03	168	5.6	8.0	6.7	100
11/03/03 – 11/09/03	168	5.0	9.2	7.3	100
11/10/03 – 11/16/03	167	6.4	10.5	7.5	100
11/17/03 – 11/23/03	168	5.8	9.4	7.6	100
11/24/03 – 11/30/03	168	8.0	10.3	9.2	100
12/01/03 – 12/07/03	168	7.9	10.7	9.3	100
12/08/03 – 12/14/03	168	7.6	10.5	9.2	100
12/15/03 – 12/21/03	168	9.4	11.5	10.4	100
12/22/03 – 12/28/03	168	9.0	11.5	10.2	100
12/29/03 – 12/31/03	72	9.0	11.2	9.7	100

FIGURE 19: DISSOLVED OXYGEN CONCENTRATION MEASURED HOURLY
AT ROUTE 83 ON THE CHICAGO SANITARY AND SHIP CANAL
FROM JANUARY 2004 THROUGH DECEMBER 2004

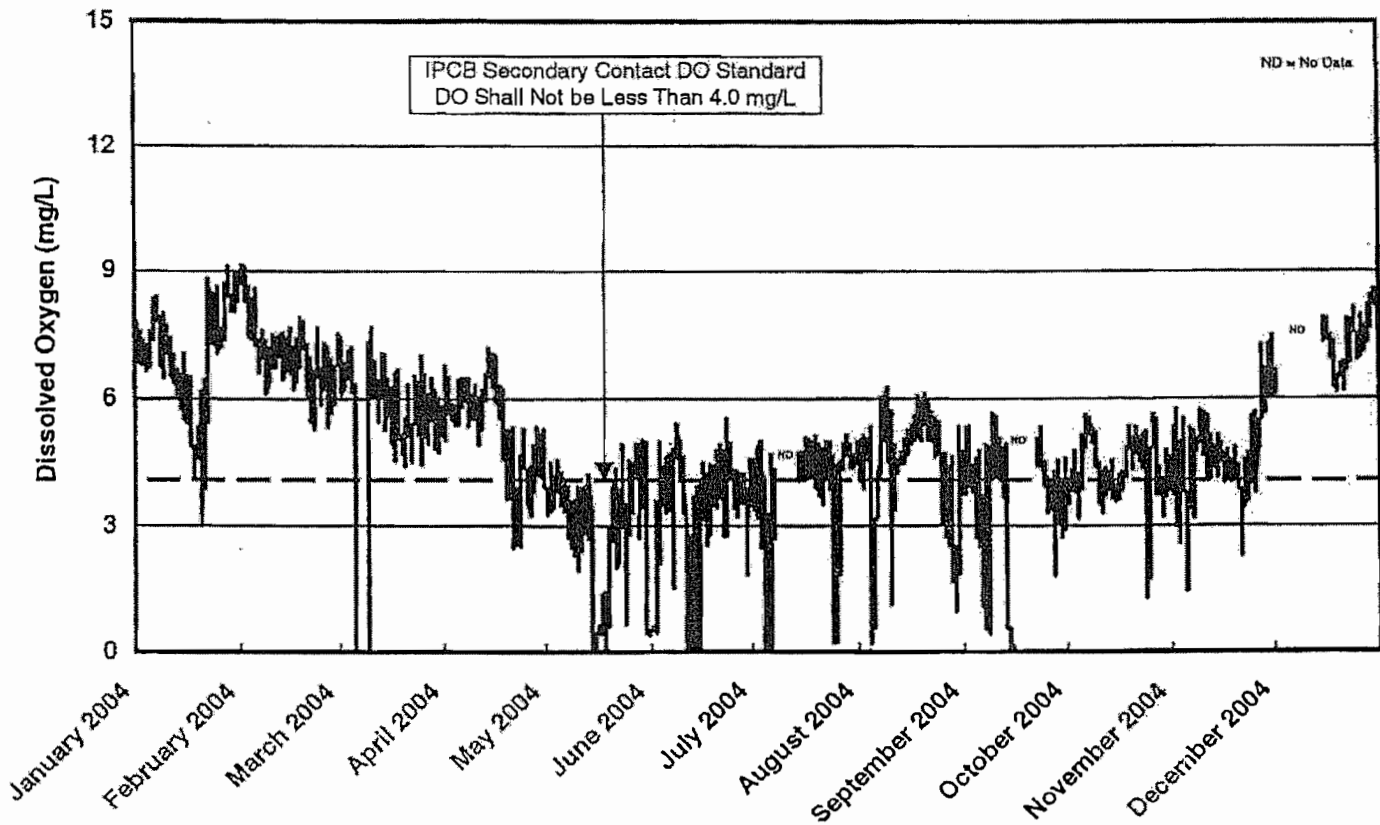

FIGURE 22: DISSOLVED OXYGEN CONCENTRATION MEASURED HOURLY
AT LOCKPORT POWERHOUSE ON THE CHICAGO SANITARY AND SHIP CANAL
FROM JANUARY 2004 THROUGH DECEMBER 2004

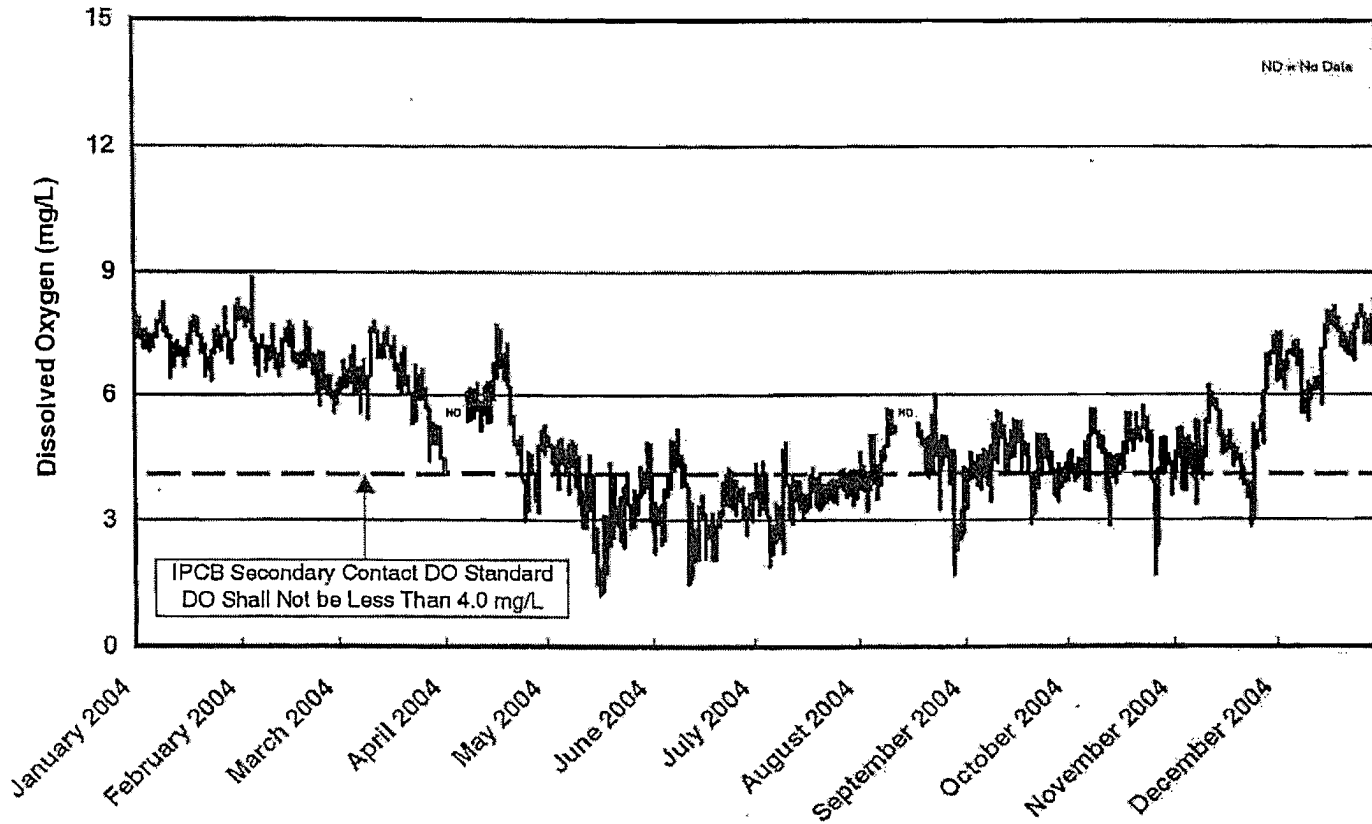

FIGURE 23: DISSOLVED OXYGEN CONCENTRATION MEASURED HOURLY
AT JEFFERSON STREET ON THE DES PLAINES RIVER
FROM JANUARY 2004 THROUGH DECEMBER 2004

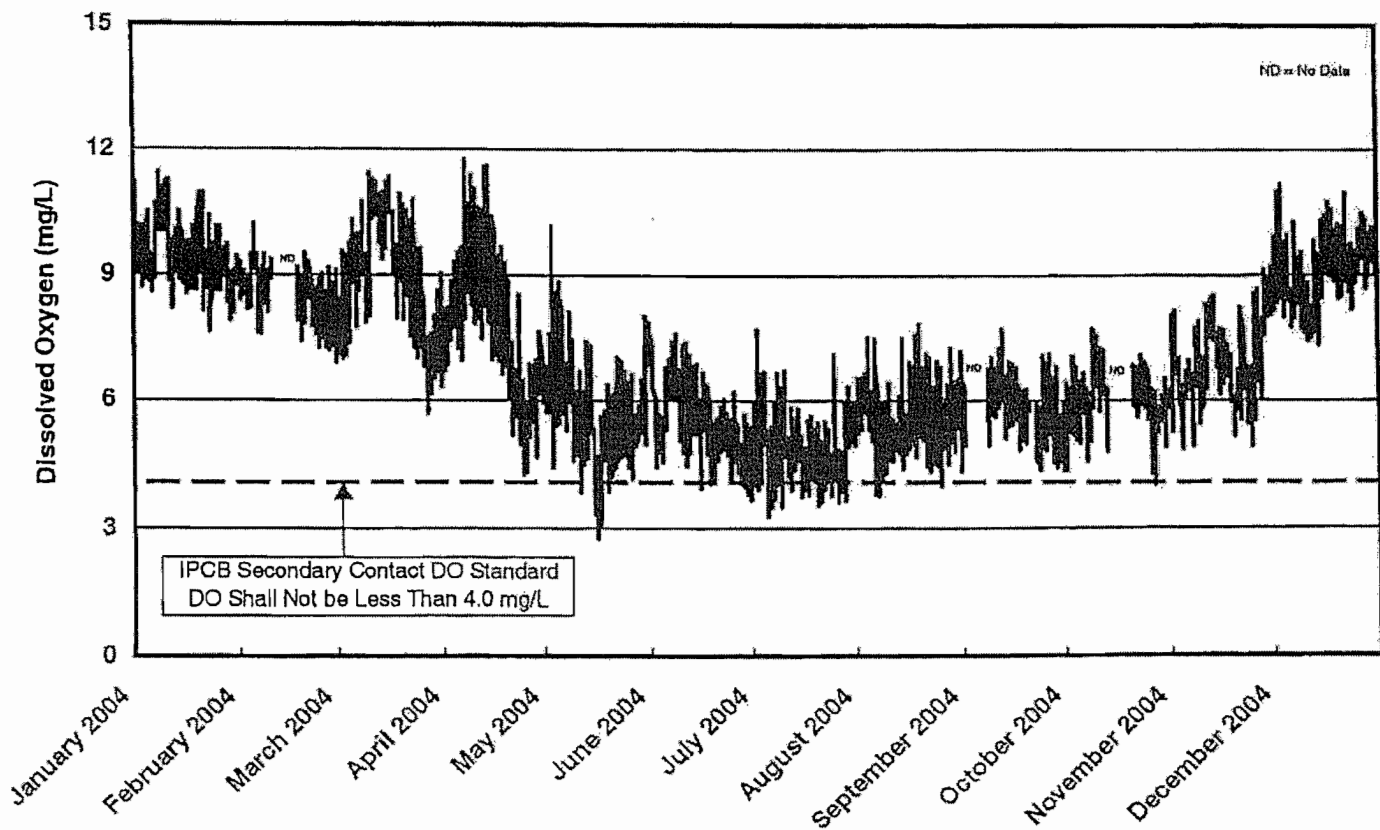

TABLE A-18: WEEKLY DO SUMMARY STATISTICS AT ROUTE 83 ON THE CHICAGO SANITARY AND SHIP CANAL DURING 2004

Monitoring Dates	Number of DO Values	DO Concentration (mg/L)			Percent DO Values Above Standard
		Min	Max	Mean	
01/01/04 - 01/04/04	96	6.7	7.8	7.2	100
01/05/04 - 01/11/04	168	6.5	8.4	7.4	100
01/12/04 - 01/18/04	168	4.2	7.1	6.0	100
01/19/04 - 01/25/04	168	3.0	8.8	6.4	93
01/26/04 - 02/01/04	168	7.2	9.2	8.4	100
02/02/04 - 02/08/04	168	6.1	9.1	7.7	100
02/09/04 - 02/15/04	168	6.4	7.6	7.1	100
02/16/04 - 02/22/04	168	5.3	7.9	6.8	100
02/23/04 - 02/29/04	168	5.3	7.6	6.6	100
03/01/04 - 03/07/04	168	0.0	7.4	4.3	65
03/08/04 - 03/14/04	168	0.0	7.7	4.8	73
03/15/04 - 03/21/04	168	4.4	6.7	5.6	100
03/22/04 - 03/28/04	168	4.4	7.0	5.7	100
03/29/04 - 04/04/04	168	4.7	6.8	5.7	100
04/05/04 - 04/11/04	167	4.9	6.5	5.9	100
04/12/04 - 04/18/04	168	4.6	7.2	6.2	100
04/19/04 - 04/25/04	168	2.5	5.3	4.2	61
04/26/04 - 05/02/04	168	3.3	5.3	4.3	64
05/03/04 - 05/09/04	168	2.3	4.5	3.6	18
05/10/04 - 05/16/04	168	0.0	4.2	2.2	1
05/17/04 - 05/23/04	167	0.1	4.9	2.5	14
05/24/04 - 05/30/04	168	0.5	5.0	3.9	62
05/31/04 - 06/06/04	167	0.4	5.0	2.6	25
06/07/04 - 06/13/04	168	0.0	5.4	3.2	38
06/14/04 - 06/20/04	168	0.0	4.8	3.2	31
06/21/04 - 06/27/04	168	2.8	5.5	4.0	55
06/28/04 - 07/04/04	168	0.0	5.0	3.6	40
07/05/04 - 07/11/04	61	0.0	4.7	1.9	16
07/12/04 - 07/18/04	110	4.1	5.1	4.6	100
07/19/04 - 07/25/04	168	0.2	5.1	4.1	79
07/26/04 - 08/01/04	168	1.8	5.1	4.5	95
08/02/04 - 08/08/04	168	0.2	6.1	4.1	65
08/09/04 - 08/15/04	168	1.1	6.3	4.6	87
08/16/04 - 08/22/04	168	4.9	6.1	5.5	100
08/23/04 - 08/29/04	168	1.0	5.5	3.8	52
08/30/04 - 09/05/04	168	1.8	5.3	4.1	61
09/06/04 - 09/12/04	168	0.4	5.6	3.8	63
09/13/04 - 09/19/04	59	0.1	4.9	1.1	8
09/20/04 - 09/26/04	110	3.3	5.3	4.2	57
09/27/04 - 10/03/04	168	1.8	4.8	3.8	37
10/04/04 - 10/10/04	169	3.2	5.6	4.7	85
10/11/04 - 10/17/04	168	3.3	4.5	4.0	44
10/18/04 - 10/24/04	168	1.3	5.3	4.5	89
10/25/04 - 10/31/04	168	1.8	5.6	4.2	65
11/01/04 - 11/07/04	168	1.5	5.7	4.0	48
11/08/04 - 11/14/04	168	4.1	5.7	4.9	100
11/15/04 - 11/21/04	168	2.3	5.0	4.2	80
11/22/04 - 11/28/04	168	3.5	7.2	5.1	89
11/29/04 - 12/05/04	58	6.0	7.5	6.7	100
12/06/04 - 12/12/04			NO DATA		
12/13/04 - 12/19/04	110	6.2	7.9	7.0	100
12/20/04 - 12/26/04	168	6.2	8.1	7.2	100
12/27/04 - 12/31/04	120	7.1	8.6	7.9	100

TABLE A-21: WEEKLY DO SUMMARY STATISTICS AT THE LOCKPORT POWERHOUSE ON THE CHICAGO SANITARY AND SHIP CANAL DURING 2004

Monitoring Dates	Number of DO Values	DO Concentration (mg/L)			Percent DO Values Above Standard
		Min	Max	Mean	
01/01/04 - 01/04/04	96	7.1	8.0	7.6	100
01/05/04 - 01/11/04	168	6.4	8.2	7.5	100
01/12/04 - 01/18/04	168	6.7	7.9	7.2	100
01/19/04 - 01/25/04	167	6.4	7.9	7.1	100
01/26/04 - 02/01/04	168	6.8	8.3	7.6	100
02/02/04 - 02/08/04	168	6.5	8.9	7.4	100
02/09/04 - 02/15/04	168	6.5	7.8	7.1	100
02/16/04 - 02/22/04	168	6.5	7.8	7.0	100
02/23/04 - 02/29/04	168	5.6	7.0	6.2	100
03/01/04 - 03/07/04	168	5.6	7.2	6.3	100
03/08/04 - 03/14/04	168	5.4	7.8	6.9	100
03/15/04 - 03/21/04	168	6.0	7.6	6.8	100
03/22/04 - 03/28/04	168	4.4	6.7	5.7	100
03/29/04 - 04/04/04	60	4.1	5.3	4.8	100
04/05/04 - 04/11/04	111	5.1	6.3	5.8	100
04/12/04 - 04/18/04	167	5.3	7.7	6.4	100
04/19/04 - 04/25/04	168	3.0	7.2	4.9	79
04/26/04 - 05/02/04	168	3.2	5.3	4.5	81
05/03/04 - 05/09/04	168	3.6	4.9	4.4	91
05/10/04 - 05/16/04	168	1.2	4.6	3.0	11
05/17/04 - 05/23/04	168	1.3	4.4	3.0	10
05/24/04 - 05/30/04	168	2.8	4.8	3.7	19
05/31/04 - 06/06/04	168	2.2	4.9	3.4	15
06/07/04 - 06/13/04	168	1.5	5.2	3.5	49
06/14/04 - 06/20/04	168	2.1	3.6	2.8	0
06/21/04 - 06/27/04	167	3.1	4.2	3.6	8
06/28/04 - 07/04/04	168	2.7	4.4	3.5	8
07/05/04 - 07/11/04	168	1.9	4.8	3.1	13
07/12/04 - 07/18/04	168	2.9	4.2	3.6	8
07/19/04 - 07/25/04	167	3.3	4.1	3.7	1
07/26/04 - 08/01/04	168	3.4	4.6	3.9	38
08/02/04 - 08/08/04	168	3.2	5.0	4.2	69
08/09/04 - 08/15/04	59	4.8	5.7	5.2	100
08/16/04 - 08/22/04	109	4.0	5.5	4.8	100
08/23/04 - 08/29/04	167	1.7	6.0	4.2	75
08/30/04 - 09/05/04	168	2.5	4.6	3.8	48
09/06/04 - 09/12/04	168	3.4	5.6	4.6	92
09/13/04 - 09/19/04	168	4.1	5.4	4.7	100
09/20/04 - 09/26/04	168	2.9	5.0	4.2	68
09/27/04 - 10/03/04	168	3.4	4.6	4.1	64
10/04/04 - 10/10/04	168	3.7	5.7	4.6	89
10/11/04 - 10/17/04	168	2.9	4.9	4.3	86
10/18/04 - 10/24/04	168	4.6	5.7	5.1	100
10/25/04 - 10/31/04	168	1.7	5.1	4.0	67
11/01/04 - 11/07/04	169	3.4	5.4	4.5	88
11/08/04 - 11/14/04	167	4.0	6.2	5.3	98
11/15/04 - 11/21/04	168	3.8	5.1	4.6	90
11/22/04 - 11/28/04	169	2.9	7.0	4.8	66
11/29/04 - 12/05/04	168	6.2	7.5	6.9	100
12/06/04 - 12/12/04	168	5.4	7.3	6.4	100
12/13/04 - 12/19/04	168	5.8	8.2	7.3	100
12/20/04 - 12/26/04	168	6.9	8.2	7.4	100
12/27/04 - 12/31/04	120	7.3	8.6	7.8	100

TABLE A-22: WEEKLY DO SUMMARY STATISTICS AT JEFFERSON STREET ON THE
DES PLAINES RIVER DURING 2004

Monitoring Dates	Number of DO Values	DO Concentration (mg/L)			Percent DO Values Above Standard
		Min	Max	Mean	
01/01/04 - 01/04/04	96	8.7	11.2	9.6	100
01/05/04 - 01/11/04	168	8.6	11.5	9.9	100
01/12/04 - 01/18/04	168	8.2	10.5	9.2	100
01/19/04 - 01/25/04	168	7.7	11.0	9.2	100
01/26/04 - 02/01/04	168	7.9	10.2	8.9	100
02/02/04 - 02/08/04	168	7.6	10.2	8.7	100
02/09/04 - 02/15/04	37	8.1	9.4	8.7	100
02/16/04 - 02/22/04	110	7.4	9.5	8.5	100
02/23/04 - 02/29/04	168	6.9	9.2	8.0	100
03/01/04 - 03/07/04	168	7.0	10.3	8.5	100
03/08/04 - 03/14/04	168	7.9	11.5	10.1	100
03/15/04 - 03/21/04	168	7.9	11.4	9.7	100
03/22/04 - 03/28/04	168	5.7	10.8	7.9	100
03/29/04 - 04/04/04	168	6.3	9.3	7.8	100
04/05/04 - 04/11/04	167	7.0	11.8	9.0	100
04/12/04 - 04/18/04	168	6.7	11.6	8.7	100
04/19/04 - 04/25/04	168	4.3	9.3	6.3	100
04/26/04 - 05/02/04	168	4.7	7.6	6.3	100
05/03/04 - 05/09/04	168	4.4	10.2	6.7	100
05/10/04 - 05/16/04	168	2.7	7.4	5.2	87
05/17/04 - 05/23/04	168	3.1	7.0	5.3	91
05/24/04 - 05/30/04	168	4.2	8.0	5.7	100
05/31/04 - 06/06/04	168	4.4	7.9	6.1	100
06/07/04 - 06/13/04	168	4.5	7.6	6.3	100
06/14/04 - 06/20/04	167	4.0	6.9	5.4	99
06/21/04 - 06/27/04	168	4.1	6.2	5.0	100
06/28/04 - 07/04/04	168	3.7	7.7	5.0	93
07/05/04 - 07/11/04	168	3.3	6.7	4.9	86
07/12/04 - 07/18/04	168	3.8	5.8	4.7	89
07/19/04 - 07/25/04	167	3.5	7.1	4.6	83
07/26/04 - 08/01/04	168	3.6	6.5	5.0	82
08/02/04 - 08/08/04	168	3.8	7.5	5.8	98
08/09/04 - 08/15/04	168	4.3	7.5	5.3	100
08/16/04 - 08/22/04	168	4.3	7.8	6.0	100
08/23/04 - 08/29/04	168	4.0	7.3	5.6	100
08/30/04 - 09/05/04	59	4.3	7.2	5.8	100
09/06/04 - 09/12/04	109	4.9	7.7	6.3	100
09/13/04 - 09/19/04	168	4.8	6.9	5.8	100
09/20/04 - 09/26/04	112	4.4	7.1	5.7	100
09/27/04 - 10/03/04	168	4.4	7.1	5.5	100
10/04/04 - 10/10/04	168	4.6	7.7	5.9	100
10/11/04 - 10/17/04	60	4.8	7.3	6.2	100
10/18/04 - 10/24/04	83	5.6	7.1	6.3	100
10/25/04 - 10/31/04	168	4.0	6.7	5.6	100
11/01/04 - 11/07/04	169	4.9	8.1	6.2	100
11/08/04 - 11/14/04	168	5.4	8.5	7.1	100
11/15/04 - 11/21/04	168	5.2	8.2	6.5	100
11/22/04 - 11/28/04	168	4.9	9.1	6.8	100
11/29/04 - 12/05/04	168	8.0	11.2	9.1	100
12/06/04 - 12/12/04	168	7.4	10.3	8.5	100
12/13/04 - 12/19/04	168	7.3	10.7	9.4	100
12/20/04 - 12/26/04	168	8.2	11.0	9.3	100
12/27/04 - 12/31/04	120	8.7	10.5	9.5	100

FIGURE 13: DISSOLVED OXYGEN CONCENTRATION MEASURED HOURLY
AT ROUTE 83 ON THE CHICAGO SANITARY AND SHIP CANAL FROM
JANUARY 2005 THROUGH DECEMBER 2005

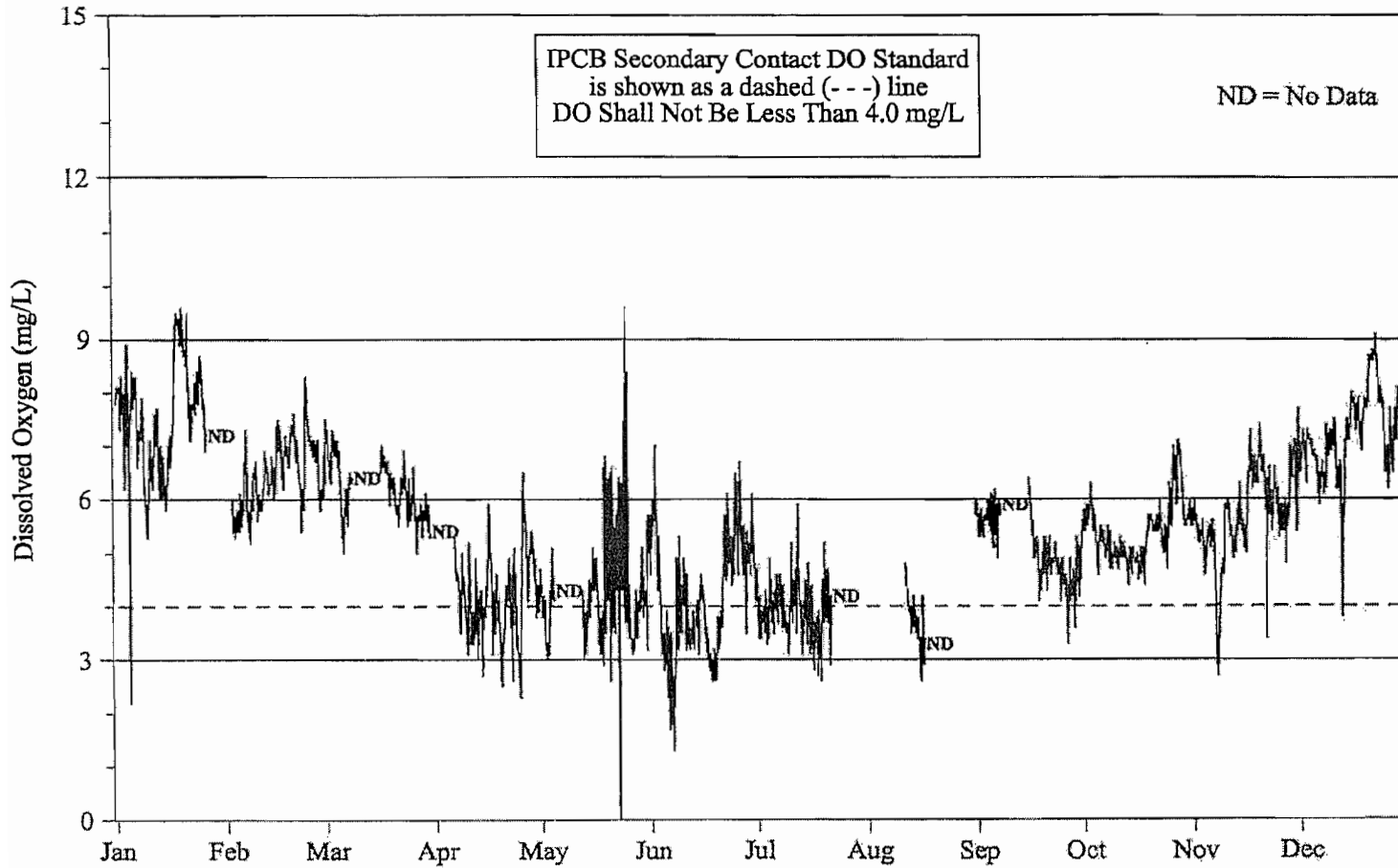

FIGURE 14: DISSOLVED OXYGEN CONCENTRATION MEASURED HOURLY
AT LOCKPORT POWERHOUSE ON THE CHICAGO SANITARY AND SHIP CANAL FROM
JANUARY 2005 THROUGH DECEMBER 2005

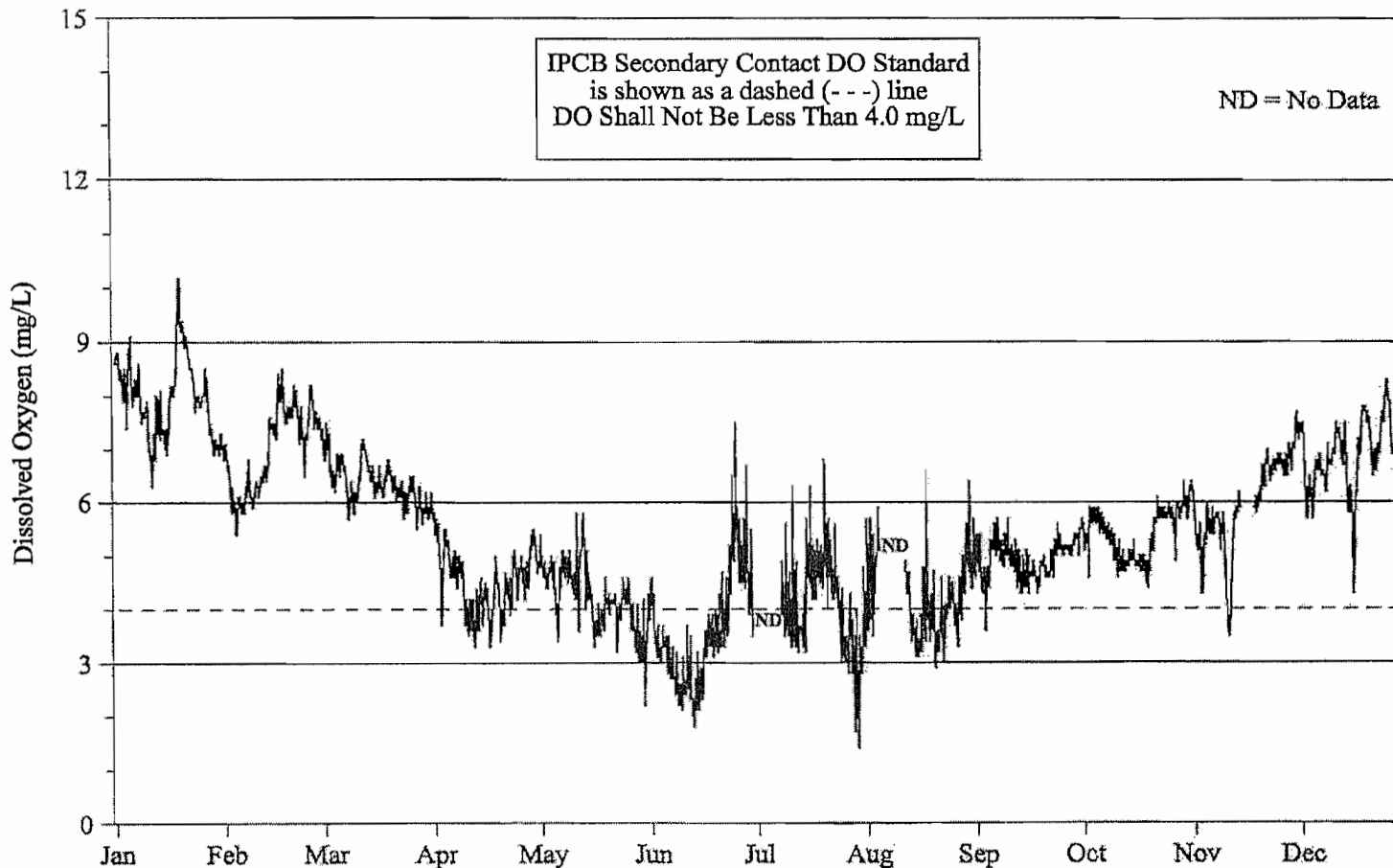

FIGURE 15: DISSOLVED OXYGEN CONCENTRATION MEASURED HOURLY
AT JEFFERSON STREET ON THE DES PLAINES RIVER FROM
JANUARY 2005 THROUGH DECEMBER 2005

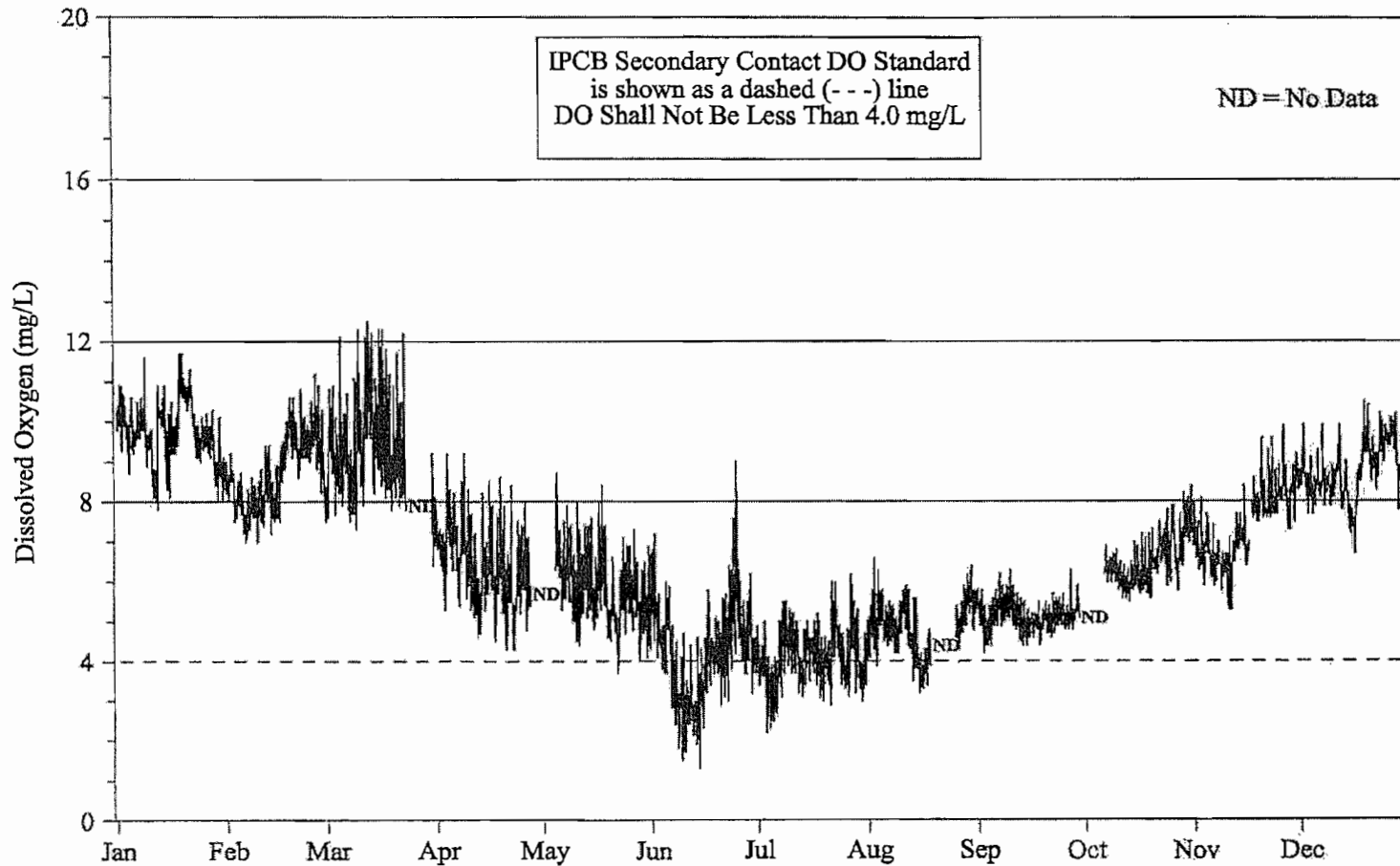

TABLE A-12: WEEKLY DO SUMMARY STATISTICS AT ROUTE 83
ON THE CHICAGO SANITARY AND SHIP CANAL DURING 2005

Monitoring Dates	Number of DO Values	DO Concentration (mg/L)			Percent DO Values Above IPCB Standard
		Min	Max	Mean	
01/01/05 - 01/02/05	48	7.3	8.3	8.0	100
01/03/05 - 01/09/05	168	2.2	8.9	7.1	97
01/10/05 - 01/16/05	168	5.7	7.7	6.7	100
01/17/05 - 01/23/05	168	7.1	9.6	8.5	100
01/24/05 - 01/30/05	58	6.9	8.7	8.0	100
01/31/05 - 02/06/05	109	5.3	7.3	5.9	100
02/07/05 - 02/13/05	168	5.2	6.9	6.2	100
02/14/05 - 02/20/05	168	6.0	7.6	6.9	100
02/21/05 - 02/27/05	168	5.4	8.3	6.7	100
02/28/05 - 03/06/05	168	5.0	7.5	6.5	100
03/07/05 - 03/13/05	36	5.5	6.5	6.2	100
03/14/05 - 03/20/05	109	5.7	7.0	6.4	100
03/21/05 - 03/27/05	168	5.0	6.9	6.0	100
03/28/05 - 04/03/05	58	5.3	6.1	5.7	100
04/04/05 - 04/10/05	109	3.1	5.3	4.2	62
04/11/05 - 04/17/05	168	2.7	5.9	4.1	54
04/18/05 - 04/24/05	168	2.3	5.1	3.8	43
04/25/05 - 05/01/05	168	3.2	6.5	4.7	86
05/02/05 - 05/08/05	59	3.0	5.1	3.9	49
05/09/05 - 05/15/05	85	3.0	5.1	4.0	53
05/16/05 - 05/22/05	189	0.0	6.8	5.1	75
05/23/05 - 05/29/05	179	0.0	9.6	4.9	62
05/30/05 - 06/05/05	168	2.3	7.0	4.4	62
06/06/05 - 06/12/05	168	1.3	5.3	3.5	31
06/13/05 - 06/19/05	168	2.6	4.6	3.5	21
06/20/05 - 06/26/05	168	3.3	6.7	5.0	87
06/27/05 - 07/03/05	168	3.3	6.1	4.4	60
07/04/05 - 07/10/05	168	3.1	5.2	4.1	55
07/11/05 - 07/17/05	168	2.7	5.9	3.9	45
07/18/05 - 07/24/05	84	2.6	5.2	3.9	41
07/25/05 - 07/31/05			NO DATA		

TABLE A-12 (Continued): WEEKLY DO SUMMARY STATISTICS AT ROUTE 83
ON THE CHICAGO SANITARY AND SHIP CANAL DURING 2005

Monitoring Dates	Number of DO Values	DO Concentration (mg/L)			Percent DO Values Above IPCB Standard
		Min	Max	Mean	
08/01/05 - 08/07/05		NO DATA			
08/08/05 - 08/14/05	84	3.4	4.8	4.0	36
08/15/05 - 08/21/05	44	2.6	4.2	3.4	5
08/22/05 - 08/28/05		NO DATA			
08/29/05 - 09/04/05	110	5.3	6.1	5.7	100
09/05/05 - 09/11/05	58	4.9	6.2	5.7	100
09/12/05 - 09/18/05	86	4.1	6.4	5.2	100
09/19/05 - 09/25/05	168	4.1	5.3	4.8	100
09/26/05 - 10/02/05	168	3.3	6.3	4.9	89
10/03/05 - 10/09/05	168	4.6	6.3	5.3	100
10/10/05 - 10/16/05	168	4.4	5.3	4.9	100
10/17/05 - 10/23/05	168	4.4	6.0	5.4	100
10/24/05 - 10/30/05	168	4.7	7.1	6.0	100
10/31/05 - 11/06/05	169	4.6	6.0	5.4	100
11/07/05 - 11/13/05	168	2.7	6.0	5.0	85
11/14/05 - 11/20/05	168	5.0	7.4	6.3	100
11/21/05 - 11/27/05	168	3.4	6.6	5.8	99
11/28/05 - 12/04/05	168	5.4	7.7	6.8	100
12/05/05 - 12/11/05	168	5.9	7.5	6.7	100
12/12/05 - 12/18/05	168	3.8	8.0	7.0	98
12/19/05 - 12/25/05	168	6.2	9.1	8.0	100
12/26/05 - 12/31/05	144	6.3	8.1	7.3	100

TABLE A-13: WEEKLY DO SUMMARY STATISTICS AT LOCKPORT POWERHOUSE
ON THE CHICAGO SANITARY AND SHIP CANAL DURING 2005

Monitoring Dates	Number of DO Values	DO Concentration (mg/L)			Percent DO Values Above IPCB Standard
		Min	Max	Mean	
01/01/05 - 01/02/05	48	8.3	8.8	8.6	100
01/03/05 - 01/09/05	168	7.4	9.1	8.1	100
01/10/05 - 01/16/05	168	6.3	8.2	7.3	100
01/17/05 - 01/23/05	168	7.7	10.2	8.8	100
01/24/05 - 01/30/05	168	6.9	8.5	7.6	100
01/31/05 - 02/06/05	168	5.4	7.3	6.2	100
02/07/05 - 02/13/05	168	5.9	7.6	6.5	100
02/14/05 - 02/20/05	168	7.2	8.5	7.8	100
02/21/05 - 02/27/05	168	6.5	8.2	7.5	100
02/28/05 - 03/06/05	168	6.2	7.5	6.8	100
03/07/05 - 03/13/05	168	5.7	7.2	6.4	100
03/14/05 - 03/20/05	168	6.1	6.8	6.4	100
03/21/05 - 03/27/05	168	5.5	6.5	6.1	100
03/28/05 - 04/03/05	168	3.7	6.2	5.5	94
04/04/05 - 04/10/05	167	3.5	5.5	4.6	84
04/11/05 - 04/17/05	168	3.3	5.0	4.0	48
04/18/05 - 04/24/05	168	3.4	5.1	4.4	79
04/25/05 - 05/01/05	168	4.2	5.5	4.9	100
05/02/05 - 05/08/05	169	3.4	5.1	4.6	92
05/09/05 - 05/15/05	168	3.3	5.8	4.5	82
05/16/05 - 05/22/05	168	3.2	4.6	3.9	47
05/23/05 - 05/29/05	168	2.2	4.6	3.8	39
05/30/05 - 06/05/05	168	2.7	4.6	3.5	17
06/06/05 - 06/12/05	168	1.8	3.7	2.6	0
06/13/05 - 06/19/05	168	2.1	4.3	3.1	1
06/20/05 - 06/26/05	168	3.3	7.5	4.7	73
06/27/05 - 07/03/05	59	3.5	6.7	4.7	86
07/04/05 - 07/10/05	86	3.3	6.3	4.1	51
07/11/05 - 07/17/05	168	3.2	6.3	4.3	56
07/18/05 - 07/24/05	168	3.0	6.8	4.6	88
07/25/05 - 07/31/05	168	1.4	5.7	3.3	14

TABLE A-13 (Continued): WEEKLY DO SUMMARY STATISTICS AT LOCKPORT POWERHOUSE ON THE CHICAGO SANITARY AND SHIP CANAL DURING 2005

Monitoring Dates	Number of DO Values	DO Concentration (mg/L)			Percent DO Values Above IPCB Standard
		Min	Max	Mean	
08/01/05 - 08/07/05	82	3.5	5.9	4.7	74
08/08/05 - 08/14/05	85	3.1	4.9	3.9	41
08/15/05 - 08/21/05	168	2.9	6.6	3.8	29
08/22/05 - 08/28/05	168	3.0	5.6	4.1	58
08/29/05 - 09/04/05	168	3.6	6.4	4.9	98
09/05/05 - 09/11/05	168	4.7	5.7	5.1	100
09/12/05 - 09/18/05	168	4.3	5.1	4.6	100
09/19/05 - 09/25/05	168	4.6	5.6	5.0	100
09/26/05 - 10/02/05	168	4.6	5.9	5.3	100
10/03/05 - 10/09/05	168	4.9	5.9	5.5	100
10/10/05 - 10/16/05	168	4.6	5.3	4.9	100
10/17/05 - 10/23/05	168	4.4	6.1	5.3	100
10/24/05 - 10/30/05	167	4.9	6.4	5.9	100
10/31/05 - 11/06/05	170	4.3	6.4	5.5	100
11/07/05 - 11/13/05	163	3.5	6.2	5.2	85
11/14/05 - 11/20/05	85	5.8	6.7	6.2	100
11/21/05 - 11/27/05	168	6.4	7.1	6.7	100
11/28/05 - 12/04/05	168	5.7	7.7	6.8	100
12/05/05 - 12/11/05	168	6.2	7.5	6.8	100
12/12/05 - 12/18/05	168	4.3	7.8	6.6	100
12/19/05 - 12/25/05	168	6.5	8.3	7.4	100
12/26/05 - 12/31/05	144	6.3	7.7	7.0	100

TABLE A-14: WEEKLY DO SUMMARY STATISTICS AT JEFFERSON STREET
ON THE DES PLAINES RIVER DURING 2005

Monitoring Dates	Number of DO Values	DO Concentration (mg/L)			Percent DO Values Above IPCB Standard
		Min	Max	Mean	
01/01/05 - 01/02/05	48	9.3	10.9	10.2	100
01/03/05 - 01/09/05	168	8.7	11.6	9.8	100
01/10/05 - 01/16/05	168	7.8	10.9	9.5	100
01/17/05 - 01/23/05	168	9.1	11.7	10.3	100
01/24/05 - 01/30/05	168	8.0	10.3	9.3	100
01/31/05 - 02/06/05	168	7.0	9.2	8.2	100
02/07/05 - 02/13/05	168	7.0	9.4	8.1	100
02/14/05 - 02/20/05	168	7.5	10.6	9.2	100
02/21/05 - 02/27/05	168	8.2	11.2	9.6	100
02/28/05 - 03/06/05	168	7.5	12.1	9.1	100
03/07/05 - 03/13/05	168	7.3	12.5	9.6	100
03/14/05 - 03/20/05	168	7.8	12.3	9.6	100
03/21/05 - 03/27/05	58	7.8	12.2	9.1	100
03/28/05 - 04/03/05	110	5.3	9.2	7.2	100
04/04/05 - 04/10/05	167	5.3	9.2	7.0	100
04/11/05 - 04/17/05	168	4.5	8.5	6.1	100
04/18/05 - 04/24/05	168	4.3	8.6	6.0	100
04/25/05 - 05/01/05	59	4.8	8.0	6.2	100
05/02/05 - 05/08/05	109	5.3	8.7	6.6	100
05/09/05 - 05/15/05	168	4.4	8.0	6.0	100
05/16/05 - 05/22/05	168	3.7	8.4	5.6	98
05/23/05 - 05/29/05	168	4.0	7.3	5.7	100
05/30/05 - 06/05/05	168	3.7	7.2	5.2	96
06/06/05 - 06/12/05	168	1.5	4.9	3.0	14
06/13/05 - 06/19/05	168	1.3	5.8	3.9	48
06/20/05 - 06/26/05	168	2.9	9.0	5.1	82
06/27/05 - 07/03/05	167	2.2	6.2	4.2	56
07/04/05 - 07/10/05	168	2.3	5.5	4.1	54
07/11/05 - 07/17/05	168	3.1	5.2	4.2	60
07/18/05 - 07/24/05	168	2.9	6.0	4.2	60
07/25/05 - 07/31/05	168	3.0	6.2	4.2	48

TABLE A-14 (Continued): WEEKLY DO SUMMARY STATISTICS AT JEFFERSON STREET
ON THE DES PLAINES RIVER DURING 2005

Monitoring Dates	Number of DO Values	DO Concentration (mg/L)			Percent DO Values Above IPCB Standard
		Min	Max	Mean	
08/01/05 - 08/07/05	168	3.9	6.6	5.1	99
08/08/05 - 08/14/05	168	3.5	5.9	4.9	94
08/15/05 - 08/21/05	83	3.2	4.8	4.0	45
08/22/05 - 08/28/05	85	4.3	6.2	5.2	100
08/29/05 - 09/04/05	168	4.2	6.4	5.2	100
09/05/05 - 09/11/05	168	4.8	6.3	5.4	100
09/12/05 - 09/18/05	168	4.4	5.6	4.9	100
09/19/05 - 09/25/05	168	4.6	5.7	5.1	100
09/26/05 - 10/02/05	82	4.8	6.3	5.2	100
10/03/05 - 10/09/05	84	6.0	6.9	6.4	100
10/10/05 - 10/16/05	168	5.5	7.0	6.1	100
10/17/05 - 10/23/05	168	5.6	7.5	6.5	100
10/24/05 - 10/30/05	168	5.8	8.3	7.0	100
10/31/05 - 11/06/05	169	5.9	8.4	6.9	100
11/07/05 - 11/13/05	168	5.3	7.7	6.5	100
11/14/05 - 11/20/05	143	6.4	9.6	7.7	100
11/21/05 - 11/27/05	168	7.3	9.9	8.2	100
11/28/05 - 12/04/05	168	7.3	9.9	8.4	100
12/05/05 - 12/11/05	168	7.9	9.9	8.5	100
12/12/05 - 12/18/05	167	6.7	10.0	8.2	100
12/19/05 - 12/25/05	168	8.3	10.5	9.3	100
12/26/05 - 12/31/05	144	7.8	10.2	9.2	100

FIGURE 13: DISSOLVED OXYGEN CONCENTRATION MEASURED HOURLY AT ROUTE 83 ON THE CHICAGO SANITARY AND SHIP CANAL FROM JANUARY 2006 THROUGH DECEMBER 2006

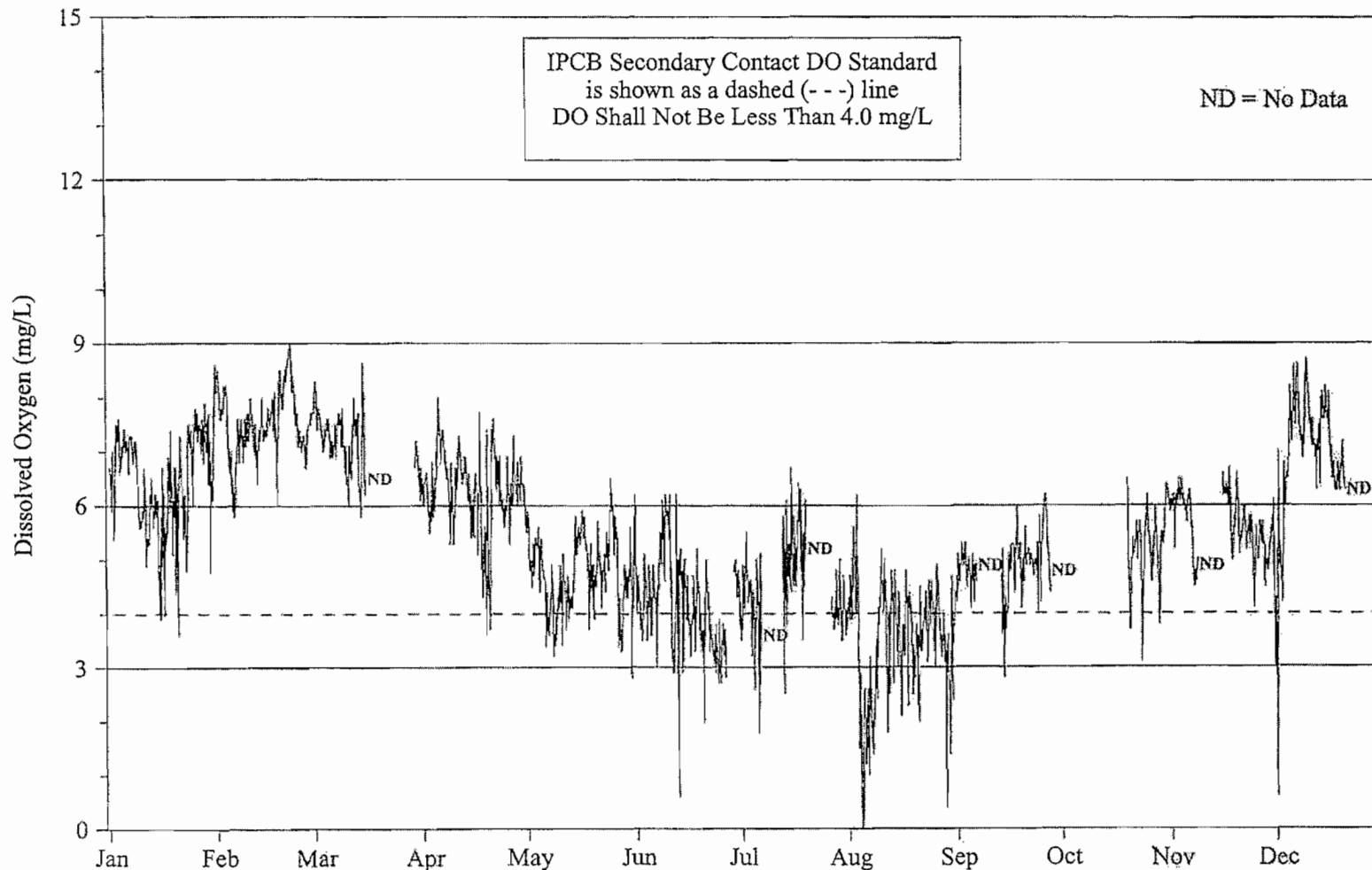

FIGURE 14: DISSOLVED OXYGEN CONCENTRATION MEASURED HOURLY AT LOCKPORT POWERHOUSE ON THE CHICAGO SANITARY AND SHIP CANAL FROM JANUARY 2006 THROUGH DECEMBER 2006

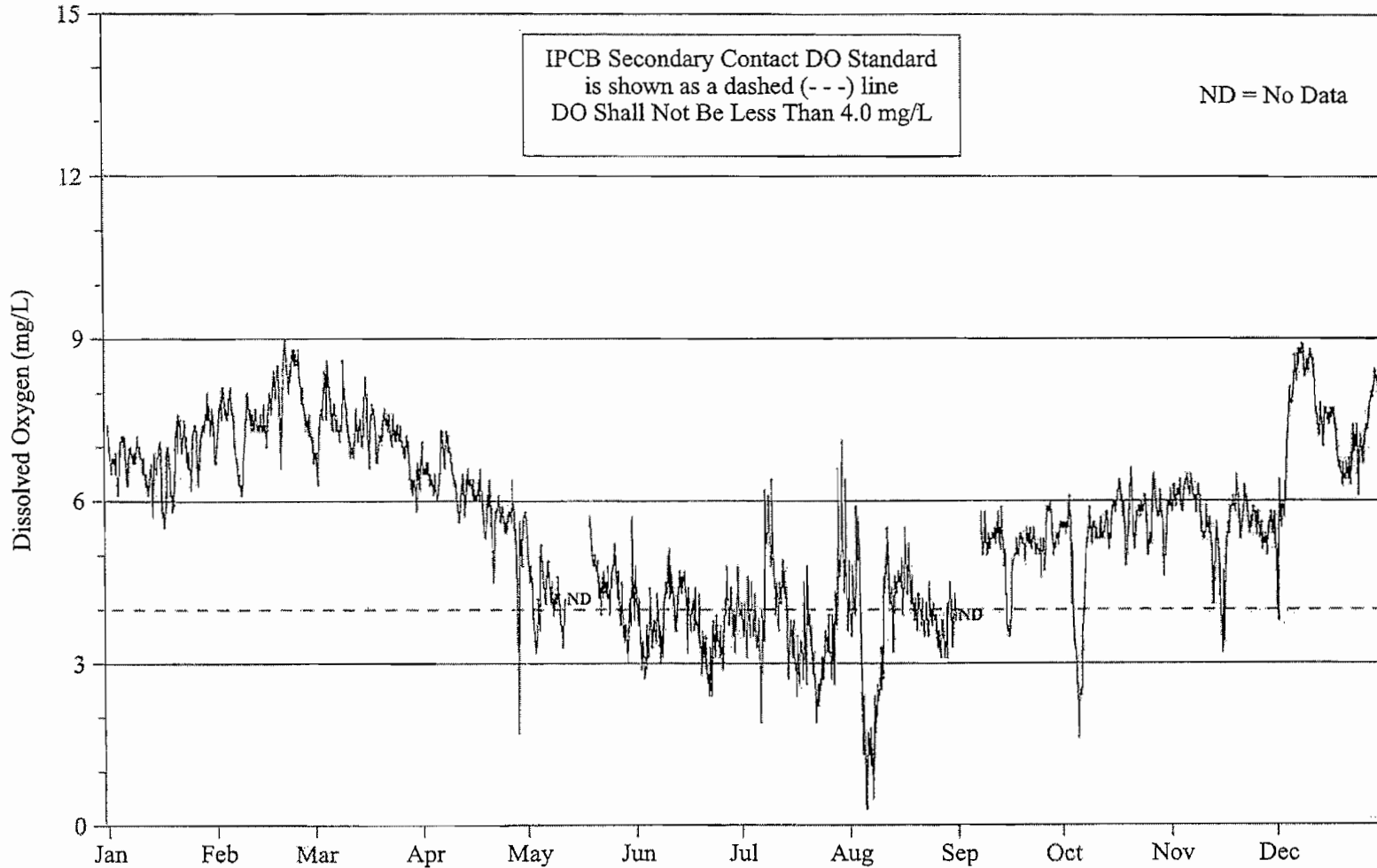

FIGURE 15: DISSOLVED OXYGEN CONCENTRATION MEASURED HOURLY AT JEFFERSON STREET ON THE DES PLAINES RIVER FROM JANUARY 2006 THROUGH DECEMBER 2006

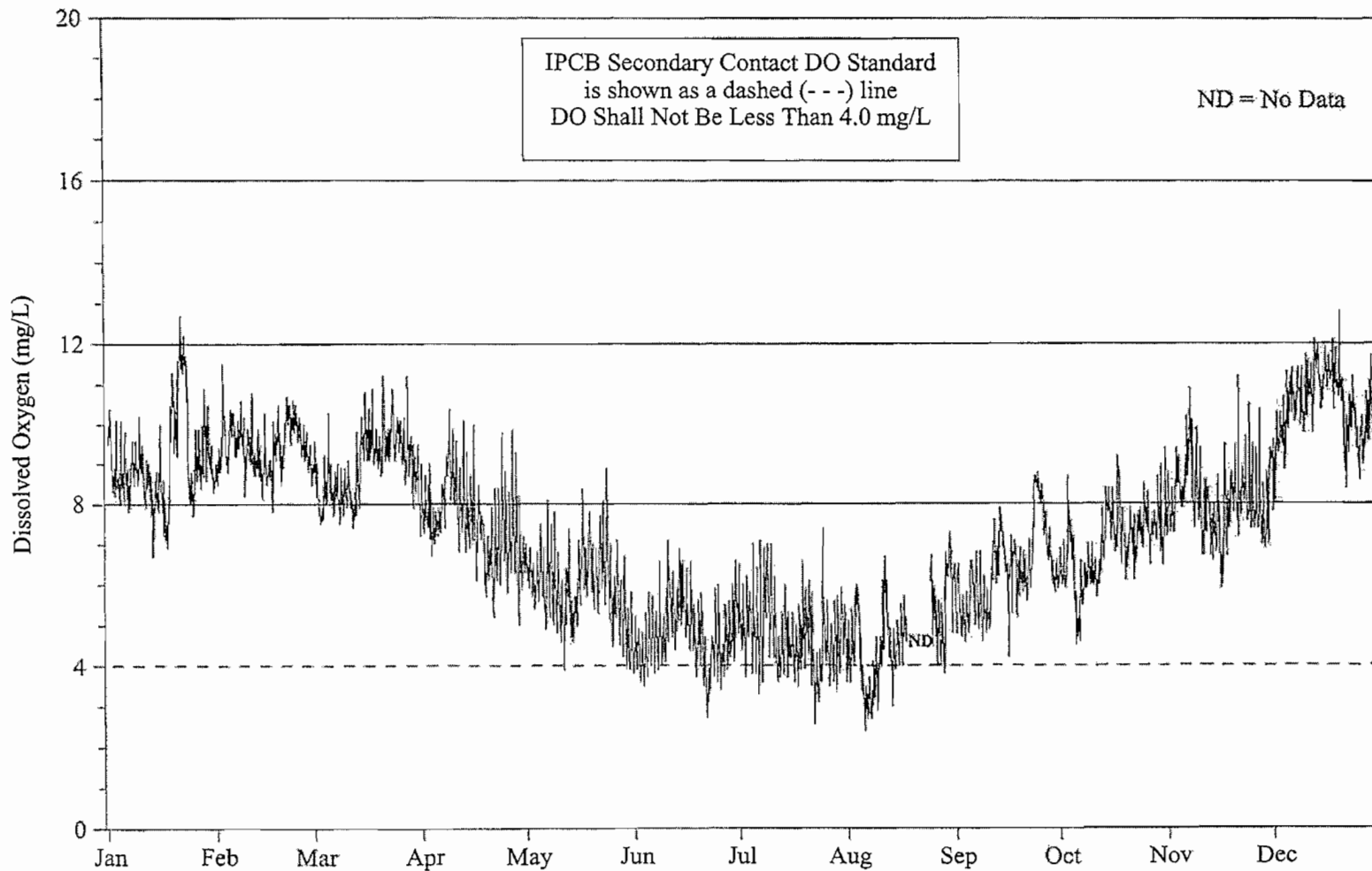

TABLE A-12: WEEKLY DO SUMMARY STATISTICS AT ROUTE 83
ON THE CHICAGO SANITARY AND SHIP CANAL DURING 2006

Monitoring Dates	Number of DO Values	DO Concentration (mg/L)			Percent DO Values Above IPCB Standard
		Minimum	Maximum	Mean	
01/01/06 - 01/01/06	24	5.9	7.0	6.6	100
01/02/06 - 01/08/06	168	5.4	7.6	7.0	100
01/09/06 - 01/15/06	168	3.9	6.7	5.6	99
01/16/06 - 01/22/06	168	3.6	7.4	6.0	99
01/23/06 - 01/29/06	168	4.8	7.9	7.1	100
01/30/06 - 02/05/06	168	5.8	8.6	7.3	100
02/06/06 - 02/12/06	168	6.4	8.0	7.3	100
02/13/06 - 02/19/06	168	6.0	8.5	7.6	100
02/20/06 - 02/26/06	168	6.7	9.0	7.8	100
02/27/06 - 03/05/06	168	6.9	8.3	7.5	100
03/06/06 - 03/12/06	168	6.0	8.0	7.2	100
03/13/06 - 03/19/06	59	5.8	8.6	6.9	100
03/20/06 - 03/26/06			NO DATA		
03/27/06 - 04/02/06	107	5.5	7.2	6.4	100
04/03/06 - 04/09/06	167	5.3	8.0	6.6	100
04/10/06 - 04/16/06	168	5.1	7.3	6.4	100
04/17/06 - 04/23/06	168	3.6	7.7	6.0	95
04/24/06 - 04/30/06	168	5.3	7.3	6.2	100
05/01/06 - 05/07/06	168	3.3	5.6	4.7	85
05/08/06 - 05/14/06	168	3.2	5.8	4.4	81
05/15/06 - 05/21/06	168	3.7	5.9	5.1	99
05/22/06 - 05/28/06	168	3.3	6.5	4.9	85
05/29/06 - 06/04/06	168	2.8	6.2	4.5	79
06/05/06 - 06/11/06	168	2.9	6.2	4.8	80
06/12/06 - 06/18/06	168	0.6	6.2	4.2	59
06/19/06 - 06/25/06	168	2.0	5.0	3.6	17
06/26/06 - 07/02/06	115	2.8	5.5	4.4	81
07/03/06 - 07/09/06	82	1.8	5.1	4.0	55
07/10/06 - 07/16/06	110	2.5	6.7	5.0	96
07/17/06 - 07/23/06	58	3.5	6.4	5.4	91
07/24/06 - 07/30/06	107	3.5	5.0	4.1	51
07/31/06 - 08/06/06	167	0.0	6.2	3.1	43
08/07/06 - 08/13/06	168	1.4	5.2	3.6	48

TABLE A-12 (Continued): WEEKLY DO SUMMARY STATISTICS AT
ROUTE 83 ON THE CHICAGO SANITARY AND SHIP CANAL DURING 2006

Monitoring Dates	Number of DO Values	DO Concentration (mg/L)			Percent DO Values Above IPCB Standard
		Minimum	Maximum	Mean	
08/14/06 - 08/20/06	168	2.0	4.8	3.6	31
08/21/06 - 08/27/06	168	3.0	4.9	3.9	40
08/28/06 - 09/03/06	168	0.4	5.3	4.1	60
09/04/06 - 09/10/06	58	4.1	5.1	4.7	100
09/11/06 - 09/17/06	98	2.8	6.0	4.6	78
09/18/06 - 09/24/06	168	4.0	5.8	5.0	100
09/25/06 - 10/01/06	58	4.4	6.2	5.5	100
10/02/06 - 10/08/06			NO DATA		
10/09/06 - 10/15/06			NO DATA		
10/16/06 - 10/22/06	86	3.7	6.5	5.1	90
10/23/06 - 10/29/06	168	3.1	6.2	5.2	93
10/30/06 - 11/05/06	169	5.2	6.5	6.1	100
11/06/06 - 11/12/06	58	4.5	6.3	5.2	100
11/13/06 - 11/19/06	110	5.0	6.7	6.0	100
11/20/06 - 11/26/06	168	4.1	6.0	5.4	100
11/27/06 - 12/03/06	168	0.6	7.0	5.0	89
12/04/06 - 12/10/06	167	6.5	8.7	7.7	100
12/11/06 - 12/17/06	168	6.3	8.2	7.2	100
12/18/06 - 12/24/06	59	6.3	7.2	6.6	100

TABLE A-13: WEEKLY DO SUMMARY STATISTICS AT LOCKPORT POWERHOUSE
ON THE CHICAGO SANITARY AND SHIP CANAL DURING 2006

Monitoring Dates	Number of DO Values	DO Concentration (mg/L)			Percent DO Values Above IPCB Standard
		Minimum	Maximum	Mean	
01/01/06 - 01/01/06	24	6.5	7.4	6.9	100
01/02/06 - 01/08/06	167	6.1	7.2	6.8	100
01/09/06 - 01/15/06	168	5.7	7.2	6.6	100
01/16/06 - 01/22/06	168	5.5	7.6	6.6	100
01/23/06 - 01/29/06	168	6.2	8.0	7.1	100
01/30/06 - 02/05/06	168	6.7	8.1	7.6	100
02/06/06 - 02/12/06	168	6.1	8.0	7.1	100
02/13/06 - 02/19/06	168	6.6	8.5	7.7	100
02/20/06 - 02/26/06	168	7.3	9.0	8.3	100
02/27/06 - 03/05/06	168	6.3	8.6	7.5	100
03/06/06 - 03/12/06	168	6.8	8.6	7.4	100
03/13/06 - 03/19/06	168	6.6	8.3	7.3	100
03/20/06 - 03/26/06	168	6.8	7.7	7.3	100
03/27/06 - 04/02/06	168	5.8	7.2	6.6	100
04/03/06 - 04/09/06	167	6.0	7.3	6.6	100
04/10/06 - 04/16/06	167	5.6	6.6	6.2	100
04/17/06 - 04/23/06	168	4.5	6.6	5.8	100
04/24/06 - 04/30/06	168	1.7	6.4	5.3	91
05/01/06 - 05/07/06	168	3.2	5.2	4.3	72
05/08/06 - 05/14/06	83	3.3	4.6	4.0	57
05/15/06 - 05/21/06	85	3.9	5.7	4.8	99
05/22/06 - 05/28/06	168	3.4	5.2	4.3	78
05/29/06 - 06/04/06	167	2.7	5.7	3.7	32
06/05/06 - 06/11/06	168	3.0	5.1	4.0	47
06/12/06 - 06/18/06	168	3.2	4.7	4.1	57
06/19/06 - 06/25/06	168	2.4	3.9	3.2	0
06/26/06 - 07/02/06	168	3.1	4.8	4.0	40
07/03/06 - 07/09/06	168	1.9	6.4	4.2	46
07/10/06 - 07/16/06	168	2.4	5.2	3.8	48
07/17/06 - 07/23/06	168	1.9	4.8	3.1	8
07/24/06 - 07/30/06	168	2.6	7.1	4.1	42
07/31/06 - 08/06/06	168	0.3	5.9	3.2	39
08/07/06 - 08/13/06	168	0.5	5.5	3.3	41

TABLE A-13 (Continued): WEEKLY DO SUMMARY STATISTICS AT LOCKPORT POWERHOUSE ON THE CHICAGO SANITARY AND SHIP CANAL DURING 2006

Monitoring Dates	Number of DO Values	DO Concentration (mg/L)			Percent DO Values Above IPCB Standard
		Minimum	Maximum	Mean	
08/14/06 - 08/20/06	168	3.6	5.5	4.4	88
08/21/06 - 08/27/06	167	3.1	4.5	3.7	17
08/28/06 - 09/03/06	78	3.1	4.5	3.8	35
09/04/06 - 09/10/06	85	5.0	5.8	5.3	100
09/11/06 - 09/17/06	168	3.5	5.9	4.9	82
09/18/06 - 09/24/06	168	4.6	5.5	5.2	100
09/25/06 - 10/01/06	169	4.7	6.0	5.4	100
10/02/06 - 10/08/06	168	1.6	6.1	4.2	57
10/09/06 - 10/15/06	168	5.1	6.0	5.5	100
10/16/06 - 10/22/06	168	4.8	6.6	5.8	100
10/23/06 - 10/29/06	168	4.6	6.5	5.7	100
10/30/06 - 11/05/06	169	4.7	6.5	6.0	100
11/06/06 - 11/12/06	168	4.1	6.5	5.7	100
11/13/06 - 11/19/06	168	3.2	6.5	5.1	87
11/20/06 - 11/26/06	168	5.1	6.3	5.7	100
11/27/06 - 12/03/06	168	3.8	7.0	5.5	99
12/04/06 - 12/10/06	168	7.1	8.9	8.3	100
12/11/06 - 12/17/06	168	7.0	8.7	7.7	100
12/18/06 - 12/24/06	168	6.1	7.4	6.7	100
12/25/06 - 12/31/06	168	6.7	8.4	7.7	100

TABLE A-14: WEEKLY DO SUMMARY STATISTICS AT JEFFERSON STREET
ON THE DES PLAINES RIVER DURING 2006

Monitoring Dates	Number of DO Values	DO Concentration (mg/L)			Percent DO Values Above IPCB Standard
		Minimum	Maximum	Mean	
01/01/06 - 01/01/06	24	9.5	10.4	9.9	100
01/02/06 - 01/08/06	168	7.8	10.1	8.8	100
01/09/06 - 01/15/06	167	6.7	10.2	8.5	100
01/16/06 - 01/22/06	168	6.9	12.7	9.7	100
01/23/06 - 01/29/06	168	7.7	11.7	9.4	100
01/30/06 - 02/05/06	168	8.3	11.5	9.4	100
02/06/06 - 02/12/06	168	8.2	10.8	9.5	100
02/13/06 - 02/19/06	168	7.8	10.5	9.1	100
02/20/06 - 02/26/06	168	8.9	10.7	9.9	100
02/27/06 - 03/05/06	168	7.5	10.3	8.6	100
03/06/06 - 03/12/06	168	7.4	9.1	8.2	100
03/13/06 - 03/19/06	168	7.7	10.9	9.4	100
03/20/06 - 03/26/06	168	8.7	11.2	9.7	100
03/27/06 - 04/02/06	168	7.1	11.2	8.6	100
04/03/06 - 04/09/06	167	6.7	10.4	8.1	100
04/10/06 - 04/16/06	168	6.1	10.1	8.0	100
04/17/06 - 04/23/06	168	5.2	9.8	7.0	100
04/24/06 - 04/30/06	167	5.0	9.9	7.0	100
05/01/06 - 05/07/06	168	4.9	8.1	6.2	100
05/08/06 - 05/14/06	168	3.9	7.8	5.5	99
05/15/06 - 05/21/06	168	5.0	8.4	6.5	100
05/22/06 - 05/28/06	168	4.2	8.9	6.0	100
05/29/06 - 06/04/06	167	3.5	6.1	4.5	77
06/05/06 - 06/11/06	168	3.8	7.1	5.0	95
06/12/06 - 06/18/06	168	3.7	6.9	5.2	99
06/19/06 - 06/25/06	168	2.7	6.0	4.2	58
06/26/06 - 07/02/06	168	3.7	6.6	5.0	96
07/03/06 - 07/09/06	168	3.3	7.1	5.3	89
07/10/06 - 07/16/06	168	3.6	6.3	4.6	79
07/17/06 - 07/23/06	168	2.6	6.6	4.4	66
07/24/06 - 07/30/06	168	3.4	7.4	4.7	76
07/31/06 - 08/06/06	168	2.4	6.0	4.2	50
08/07/06 - 08/13/06	168	2.7	6.7	4.3	61

TABLE A-14 (Continued): WEEKLY DO SUMMARY STATISTICS AT JEFFERSON STREET ON THE DES PLAINES RIVER DURING 2006

Monitoring Dates	Number of DO Values	DO Concentration (mg/L)			Percent DO Values Above IPCB Standard
		Minimum	Maximum	Mean	
08/14/06 - 08/20/06	83	3.9	5.7	4.6	88
08/21/06 - 08/27/06	85	4.0	6.7	5.2	99
08/28/06 - 09/03/06	168	3.8	7.3	5.7	98
09/04/06 - 09/10/06	168	4.6	6.8	5.6	100
09/11/06 - 09/17/06	168	4.2	7.9	6.7	100
09/18/06 - 09/24/06	168	5.2	8.8	6.9	100
09/25/06 - 10/01/06	168	5.8	8.5	6.8	100
10/02/06 - 10/08/06	168	4.5	8.7	6.2	100
10/09/06 - 10/15/06	168	5.7	8.4	6.9	100
10/16/06 - 10/22/06	168	6.1	9.2	7.3	100
10/23/06 - 10/29/06	168	6.5	9.0	7.5	100
10/30/06 - 11/05/06	169	6.5	9.4	8.1	100
11/06/06 - 11/12/06	168	6.7	10.9	8.4	100
11/13/06 - 11/19/06	168	5.9	9.5	7.7	100
11/20/06 - 11/26/06	168	7.2	11.2	8.3	100
11/27/06 - 12/03/06	168	6.9	10.7	8.7	100
12/04/06 - 12/10/06	168	8.9	11.7	10.6	100
12/11/06 - 12/17/06	168	9.8	12.1	11.2	100
12/18/06 - 12/24/06	168	8.4	12.8	10.4	100
12/25/06 - 12/31/06	168	8.6	11.7	9.9	100

APPENDIX D

STATISTICAL ANALYSIS – EXISTING EFFLUENT DATA

CITGO AMMONIA
95TH PERCENTILE EFFLUENT CALCULATIONS

Definitions
k = number of samples
n = number of samples per month
$X_{0.95(n)}$ = 95 th percentile 30 day monthly average limit
$X_{0.95(y)}$ = 95 th percentile daily maximum limit
$y_i = \ln(x_i)$
$\mu_y = \sum(y_i)/(k)$
$\sigma_y^2 = \sum(y_i - \mu_y)^2 / (k-1)$
$E(X) = \exp[\mu_y + (\sigma_y^2/2)]$
$V(X) = \exp[2\mu_y + (\sigma_y^2)] [\exp(\sigma_y^2) - 1]$
$\sigma_n^2 = \ln\{V(X)/[n[E(X)]^2 + 1]\}$
$\mu_n = \ln(E(X)) - 0.5\sigma_n^2$
$cv_n = [\exp(\sigma_n^2) - 1]^{1/2}$
$X_{0.95(n)} = \exp(\mu_n + 1.645\sigma_n)$
$X_{0.95(y)} = \exp(\mu_y + 1.645\sigma_y)$

Calculated Values
k = 509
n = 8.5
$\mu_y = 0.184$
$\sigma_y^2 = 1.753$
E(X) = 2.89
V(X) = 39.78
$\sigma_n^2 = 0.45$
$\mu_n = 0.84$
cv _n = 0.75
$X_{0.95(n)} = 6.93$ ppm
$X_{0.95(y)} = 10.61$ ppm

CITGO AMMONIA
EFFLUENT DATA HISTOGRAM

Bin	Frequency
0.05	1
0.98	268
1.92	65
2.85	33
3.79	22
4.72	12
5.65	18
6.59	13
7.52	11
8.46	18
9.39	4
10.33	8
11.26	7
12.19	6
13.13	3
14.06	4
15.00	3
15.93	7
16.86	3
17.80	2
18.73	0
19.67	0
More	1

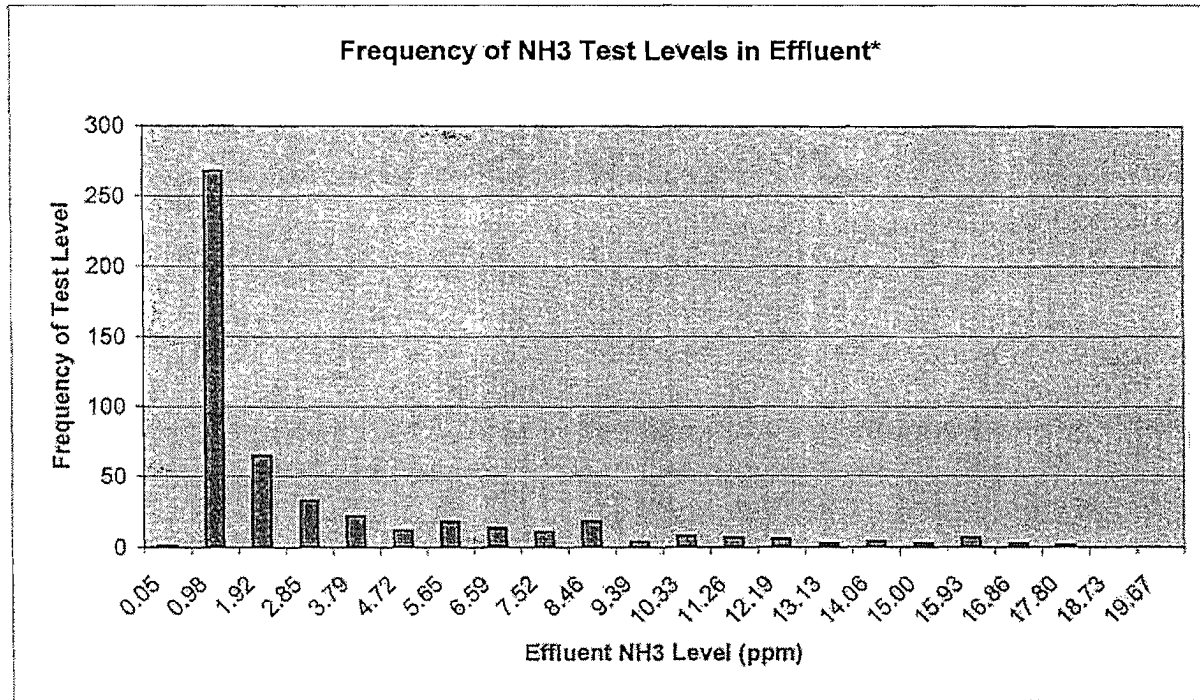

*Fits Lognormal Distribution

CITGO AMMONIA
EFFLUENT CALCULATIONS

Date	ppm-NH ₃ N = X	Y	(Y - μ _y) ²
08/05/02	0.31	-1.171	1.837
08/07/02	0.80	-0.223	0.166
08/12/02	0.24	-1.427	2.596
08/14/02	0.39	-0.942	1.267
08/19/02	0.44	-0.821	1.010
08/21/02	0.14	-1.966	4.624
08/26/02	0.12	-2.120	5.311
08/28/02	0.08	-2.526	7.344
09/02/02	0.14	-1.966	4.624
09/04/02	0.12	-2.120	5.311
09/09/02	0.31	-1.171	1.837
09/11/02	0.32	-1.139	1.752
09/16/02	1.35	0.300	0.013
09/17/02	5.50	1.705	2.312
09/23/02	1.21	0.191	0.000
09/25/02	0.67	-0.400	0.342
09/30/02	0.24	-1.427	2.596
10/02/02	0.54	-0.616	0.641
10/07/02	0.38	-0.968	1.327
10/09/02	0.84	-0.174	0.129
10/14/02	1.82	0.599	0.172
10/16/02	1.24	0.215	0.001
10/22/02	0.52	-0.654	0.702
10/25/02	0.56	-0.580	0.584
10/28/02	0.40	-0.916	1.211
10/31/02	0.51	-0.673	0.735
11/04/02	0.38	-0.968	1.327
11/06/02	4.23	1.442	1.583
11/12/02	2.74	1.008	0.679
11/13/02	3.49	1.250	1.136
11/18/02	1.58	0.457	0.075
11/20/02	0.94	-0.062	0.061
11/25/02	0.95	-0.051	0.055
11/27/02	0.64	-0.446	0.398
12/02/02	1.04	0.039	0.021
12/04/02	0.25	-1.386	2.467
12/09/02	0.14	-1.966	4.624
12/11/02	0.34	-1.079	1.595
12/16/02	1.68	0.519	0.112
01/01/03	15.7	2.754	6.602
01/02/03	11.1	2.407	4.941
01/06/03	3.66	1.297	1.239
01/08/03	1.82	0.599	0.172
01/13/03	0.87	-0.139	0.105
01/15/03	0.50	-0.693	0.770
01/20/03	0.15	-1.897	4.332
01/22/03	0.78	-0.248	0.187
01/27/03	0.90	-0.105	0.084
01/29/03	0.66	-0.416	0.360
02/03/03	1.13	0.122	0.004

$y_i = \ln(x_i)$	$\sum(y_i) = 93.77$
	$k = 509$
$\mu_y = \sum(y_i)/(k)$	$\mu_y = 0.18$
	$\sum(y_i - \mu_y)^2 = 890.34$
$\sigma_y^2 = \sum(y_i - \mu_y)^2/(k-1)$	$\sigma_y^2 = 1.75$

CITGO AMMONIA
EFFLUENT CALCULATIONS

Date	ppm-NH ₃ N = X	Y	(Y - μ _y) ²
02/05/03	0.72	-0.329	0.263
02/10/03	0.80	-0.223	0.166
02/12/03	1.62	0.482	0.089
02/17/03	0.31	-1.171	1.837
02/19/03	0.54	-0.616	0.641
02/24/03	1.42	0.351	0.028
02/26/03	1.52	0.419	0.055
03/03/03	1.53	0.425	0.058
03/05/03	1.26	0.231	0.002
03/10/03	0.44	-0.821	1.010
03/12/03	1.90	0.642	0.209
03/17/03	0.58	-0.545	0.531
03/20/03	0.70	-0.357	0.293
03/25/03	0.89	-0.117	0.090
03/27/03	1.40	0.336	0.023
03/31/03	3.08	1.125	0.885
04/02/03	3.74	1.319	1.288
04/07/03	1.90	0.642	0.209
04/09/03	1.70	0.531	0.120
04/14/03	2.02	0.703	0.269
04/16/03	1.47	0.385	0.040
04/21/03	0.75	-0.288	0.223
04/23/03	0.70	-0.357	0.293
04/28/03	1.38	0.322	0.019
04/30/03	1.09	0.086	0.010
05/05/03	4.54	1.513	1.765
05/07/03	2.10	0.742	0.311
05/12/03	2.88	1.058	0.763
05/14/03	6.12	1.812	2.648
05/19/03	13.60	2.610	5.885
05/21/03	8.77	2.171	3.949
05/26/03	2.68	0.986	0.643
05/28/03	8.13	2.096	3.653
06/02/03	2.72	1.001	0.667
06/04/03	6.17	1.820	2.675
06/09/03	4.01	1.389	1.451
06/11/03	5.32	1.671	2.212
06/16/03	2.62	0.963	0.607
06/18/03	5.29	1.666	2.195
06/23/03	3.13	1.141	0.915
06/25/03	2.57	0.944	0.577
06/30/03	1.38	0.322	0.019
07/02/03	2.39	0.871	0.472
07/07/03	1.55	0.438	0.065
07/09/03	1.00	0.000	0.034
07/14/03	0.52	-0.654	0.702
07/16/03	0.82	-0.198	0.146
07/21/03	0.73	-0.315	0.249
07/23/03	1.13	0.122	0.004
07/28/03	0.70	-0.357	0.293
07/30/03	0.64	-0.446	0.398

**CITGO AMMONIA
EFFLUENT CALCULATIONS**

Date	ppm-NH ₃ N = X	Y	(Y - μ _y) ²
08/04/03	0.50	-0.693	0.770
08/06/03	0.68	-0.386	0.325
08/11/03	0.33	-1.109	1.672
08/13/03	0.20	-1.609	3.217
08/18/03	0.89	-0.117	0.090
08/20/03	0.34	-1.079	1.595
08/25/03	0.54	-0.616	0.641
08/27/03	0.56	-0.580	0.584
09/02/03	1.36	0.307	0.015
09/03/03	0.80	-0.223	0.166
09/08/03	0.25	-1.386	2.467
09/10/03	0.30	-1.204	1.927
09/15/03	0.54	-0.616	0.641
09/17/03	0.84	-0.174	0.129
09/22/03	0.81	-0.211	0.156
09/24/03	0.61	-0.494	0.460
09/29/03	0.80	-0.223	0.166
10/01/03	2.10	0.742	0.311
10/13/03	5.08	1.625	2.077
10/15/03	3.24	1.176	0.983
10/20/03	0.99	-0.010	0.038
10/22/03	0.71	-0.342	0.277
10/27/03	0.65	-0.431	0.378
10/29/03	0.67	-0.400	0.342
11/03/04	1.26	0.230	0.002
11/05/04	0.32	-1.143	1.760
11/12/04	0.52	-0.656	0.706
11/17/04	10.39	2.341	4.651
11/19/04	6.56	1.881	2.879
11/24/04	7.00	1.946	3.104
11/25/04	9.48	2.249	4.264
12/01/04	4.55	1.515	1.771
12/03/04	1.33	0.285	0.010
12/08/04	2.24	0.806	0.387
12/10/04	6.82	1.920	3.012
12/15/04	20.60	3.025	8.072
12/29/04	12.40	2.518	5.445
01/01/04	15.00	2.708	6.370
01/05/04	11.40	2.434	5.060
01/07/04	11.80	2.468	5.216
01/12/04	8.36	2.123	3.761
01/14/04	2.68	0.986	0.643
01/19/04	0.66	-0.416	0.360
01/21/04	0.46	-0.777	0.923
01/26/04	0.50	-0.693	0.770
01/28/04	0.66	-0.416	0.360
02/02/04	0.60	-0.511	0.483
02/04/04	0.50	-0.693	0.770
02/09/04	0.52	-0.654	0.702
02/11/04	0.46	-0.777	0.923
02/16/04	0.44	-0.821	1.010

**CITGO AMMONIA
EFFLUENT CALCULATIONS**

Date	ppm-NH ₃ N = X	Y	(Y - μ _y) ²
02/18/04	0.46	-0.777	0.923
02/23/04	0.45	-0.799	0.966
02/25/04	0.14	-1.966	4.624
03/02/04	0.44	-0.821	1.010
03/03/04	0.10	-2.303	6.184
03/08/04	0.50	-0.693	0.770
03/10/04	0.61	-0.494	0.460
03/15/04	0.73	-0.315	0.249
03/17/04	0.54	-0.616	0.641
03/22/04	0.74	-0.301	0.236
03/24/04	0.87	-0.139	0.105
03/29/04	0.83	-0.186	0.137
03/31/04	0.66	-0.416	0.360
04/05/04	0.48	-0.734	0.843
04/07/04	0.23	-1.470	2.735
04/12/04	0.58	-0.545	0.531
04/14/04	0.24	-1.427	2.596
04/19/04	0.56	-0.580	0.584
04/21/04	0.23	-1.470	2.735
04/26/04	0.16	-1.833	4.067
04/28/04	0.30	-1.204	1.927
05/03/04	0.42	-0.868	1.106
05/06/04	0.86	-0.151	0.112
05/10/04	0.74	-0.301	0.236
05/12/04	0.36	-1.022	1.454
05/17/04	0.50	-0.693	0.770
05/19/04	0.25	-1.386	2.467
05/24/04	0.65	-0.431	0.378
05/26/04	0.38	-0.968	1.327
05/31/04	0.24	-1.427	2.596
06/02/04	0.09	-2.408	6.719
06/07/04	0.21	-1.561	3.045
06/09/04	0.39	-0.942	1.267
06/14/04	0.26	-1.347	2.345
06/16/04	0.06	-2.813	8.986
06/21/04	0.39	-0.942	1.267
06/23/04	0.26	-1.347	2.345
06/28/04	0.48	-0.734	0.843
06/30/04	0.51	-0.673	0.735
07/05/04	0.39	-0.942	1.267
07/07/04	0.30	-1.204	1.927
07/12/04	0.41	-0.892	1.157
07/14/04	0.38	-0.968	1.327
07/19/04	0.40	-0.916	1.211
07/21/04	0.56	-0.580	0.584
07/26/04	0.47	-0.755	0.882
07/28/04	0.45	-0.799	0.966
08/02/04	0.44	-0.821	1.010
08/04/04	0.55	-0.598	0.612
08/09/04	0.41	-0.892	1.157
08/13/04	1.28	0.247	0.004

**CITGO AMMONIA
EFFLUENT CALCULATIONS**

Date	ppm-NH ₃ N = X	Y	(Y - μ _y) ²
08/16/04	0.49	-0.713	0.806
08/18/04	0.36	-1.022	1.454
08/23/04	0.34	-1.079	1.595
08/25/04	0.36	-1.022	1.454
08/30/04	0.39	-0.942	1.267
09/01/04	0.24	-1.427	2.596
09/06/04	0.29	-1.238	2.022
09/08/04	0.55	-0.598	0.612
09/13/04	0.79	-0.236	0.176
09/15/04	0.41	-0.892	1.157
09/20/04	0.18	-1.715	3.606
09/22/04	0.21	-1.561	3.045
09/27/04	0.46	-0.777	0.923
09/29/04	0.51	-0.673	0.735
10/08/04	6.44	1.863	2.817
10/09/04	7.26	1.982	3.233
10/11/04	4.44	1.491	1.707
10/13/04	2.30	0.833	0.421
10/18/04	1.10	0.095	0.008
10/20/04	0.87	-0.139	0.105
10/25/04	0.85	-0.163	0.120
10/27/04	1.85	0.615	0.186
11/01/04	4.04	1.396	1.469
11/03/04	15.70	2.754	6.602
11/17/04	10.20	2.322	4.572
11/18/04	17.70	2.874	7.233
11/24/04	14.80	2.695	6.302
11/25/04	14.60	2.681	6.234
11/29/04	7.64	2.033	3.419
12/01/05	13.00	2.565	5.668
12/06/05	2.44	0.892	0.501
12/08/05	8.03	2.083	3.606
12/13/05	10.80	2.380	4.819
12/15/05	4.80	1.569	1.917
12/20/05	1.30	0.262	0.006
12/22/05	0.82	-0.198	0.146
12/27/05	0.79	-0.236	0.176
12/29/05	0.51	-0.673	0.735
01/03/05	0.74	-0.301	0.236
01/05/05	1.56	0.445	0.068
01/10/05	7.74	2.046	3.468
01/12/05	8.34	2.121	3.751
01/18/05	0.20	-1.609	3.217
01/19/05	0.53	-0.635	0.671
01/24/05	0.36	-1.022	1.454
01/26/05	0.45	-0.799	0.966
01/31/05	0.68	-0.386	0.325
02/02/05	0.58	-0.545	0.531
02/07/05	1.00	0.000	0.034
02/09/05	0.88	-0.128	0.097
02/14/05	0.65	-0.431	0.378

**CITGO AMMONIA
EFFLUENT CALCULATIONS**

Date	ppm-NH ₃ N = X	Y	(Y - μ _y) ²
02/16/05	0.39	-0.942	1.267
02/21/05	0.49	-0.713	0.806
02/23/05	0.51	-0.673	0.735
02/28/05	0.54	-0.616	0.641
03/02/05	0.50	-0.693	0.770
03/07/05	0.43	-0.844	1.057
03/09/05	1.44	0.365	0.033
03/15/05	0.32	-1.139	1.752
03/16/05	0.60	-0.511	0.483
03/21/05	0.09	-2.408	6.719
03/23/05	0.27	-1.309	2.231
03/28/05	0.92	-0.083	0.072
03/30/05	0.55	-0.598	0.612
04/04/05	0.36	-1.022	1.454
04/06/05	0.60	-0.511	0.483
04/11/05	0.68	-0.386	0.325
04/14/05	0.51	-0.673	0.735
04/18/05	0.64	-0.446	0.398
04/20/05	0.75	-0.288	0.223
04/25/05	0.50	-0.693	0.770
04/27/05	0.31	-1.171	1.837
05/02/05	0.90	-0.105	0.084
05/04/05	0.31	-1.171	1.837
05/09/05	0.80	-0.223	0.166
05/11/05	0.67	-0.400	0.342
05/16/05	0.64	-0.446	0.398
05/18/05	0.47	-0.755	0.882
05/23/05	0.41	-0.892	1.157
05/25/05	0.28	-1.273	2.123
05/30/05	0.61	-0.494	0.460
06/01/05	0.36	-1.022	1.454
06/06/05	0.53	-0.635	0.671
06/08/05	0.47	-0.755	0.882
06/13/05	0.44	-0.821	1.010
06/15/05	0.93	-0.073	0.066
06/20/05	0.57	-0.562	0.557
06/22/05	0.70	-0.357	0.293
06/27/05	0.78	-0.248	0.187
06/29/05	1.04	0.039	0.021
07/04/05	5.63	1.728	2.384
07/06/05	7.54	2.020	3.371
07/11/05	6.13	1.813	2.654
07/13/05	7.52	2.018	3.361
07/18/05	8.18	2.102	3.677
07/20/05	9.44	2.245	4.247
07/25/05	11.90	2.477	5.255
07/27/05	14.00	2.639	6.026
08/01/05	4.98	1.605	2.020
08/03/05	5.40	1.686	2.257
08/08/05	4.44	1.491	1.707
08/10/05	5.30	1.668	2.201

CITGO AMMONIA
EFFLUENT CALCULATIONS

Date	ppm-NH ₃ N = X	Y	(Y - μ _y) ²
08/15/05	7.16	1.969	3.184
08/17/05	7.11	1.962	3.159
08/22/05	2.94	1.078	0.800
08/24/05	1.95	0.668	0.234
08/29/05	7.34	1.993	3.273
08/31/05	6.20	1.825	2.691
09/05/05	2.46	0.900	0.513
09/08/05	2.08	0.732	0.300
09/12/05	0.83	-0.186	0.137
09/14/05	1.66	0.507	0.104
09/19/05	11.80	2.468	5.216
09/21/05	13.20	2.580	5.741
09/26/05	9.02	2.199	4.061
09/28/05	11.90	2.477	5.255
10/03/05	13.20	2.580	5.741
10/05/05	11.20	2.416	4.980
10/10/05	10.30	2.332	4.614
10/20/05	3.28	1.188	1.007
10/21/05	5.52	1.708	2.323
10/24/05	9.68	2.270	4.351
10/26/05	10.00	2.303	4.487
10/31/05	10.30	2.332	4.614
11/02/06	15.40	2.734	6.503
11/09/06	6.19	1.823	2.685
11/10/06	8.14	2.097	3.658
11/15/06	3.27	1.185	1.001
11/18/06	11.20	2.416	4.980
11/22/06	0.35	-1.050	1.523
11/24/06	0.68	-0.386	0.325
11/28/06	0.87	-0.139	0.105
11/30/06	0.99	-0.010	0.038
12/05/06	1.30	0.262	0.006
12/07/06	1.57	0.451	0.071
12/12/06	1.36	0.307	0.015
12/14/06	2.43	0.888	0.495
12/19/06	2.27	0.820	0.404
12/21/06	2.77	1.019	0.697
12/26/06	5.40	1.686	2.257
12/28/06	8.38	2.126	3.770
01/02/06	10.20	2.322	4.572
01/04/06	15.10	2.715	6.403
01/09/06	11.00	2.398	4.900
01/11/06	8.32	2.119	3.742
01/16/06	0.86	-0.151	0.112
01/18/06	0.34	-1.079	1.595
01/23/06	0.55	-0.598	0.612
01/25/06	0.63	-0.462	0.418
01/30/06	3.02	1.105	0.848
02/01/06	5.68	1.737	2.411
02/06/06	8.85	2.180	3.985
02/08/06	8.44	2.133	3.798

CITGO AMMONIA
EFFLUENT CALCULATIONS

Date	ppm-NH ₃ N = X	Y	(Y - μ _y) ²
02/13/06	4.87	1.583	1.957
02/15/06	15.60	2.747	6.569
02/20/06	7.86	2.062	3.525
02/22/06	7.20	1.974	3.204
02/27/06	16.00	2.773	6.700
03/01/06	15.30	2.728	6.470
03/06/06	3.42	1.230	1.093
03/08/06	8.19	2.103	3.681
03/13/06	8.30	2.116	3.733
03/15/06	4.60	1.526	1.801
03/21/06	5.90	1.775	2.530
03/22/06	12.70	2.542	5.557
03/27/06	5.30	1.668	2.201
03/29/06	3.72	1.314	1.276
04/03/06	1.88	0.631	0.200
04/05/06	6.06	1.802	2.616
04/10/06	2.84	1.044	0.739
04/12/06	5.58	1.719	2.356
04/17/06	7.28	1.985	3.243
04/19/06	5.52	1.708	2.323
04/24/06	10.40	2.342	4.655
04/27/06	17.00	2.833	7.017
05/01/06	14.60	2.681	6.234
05/03/06	16.20	2.785	6.764
05/08/06	7.73	2.045	3.463
05/10/06	16.40	2.797	6.828
05/19/06	1.94	0.663	0.229
05/20/06	3.04	1.112	0.861
05/22/06	3.36	1.212	1.056
05/24/06	5.16	1.641	2.122
05/29/06	0.96	-0.041	0.051
05/31/06	0.49	-0.713	0.806
06/05/06	0.05	-2.996	10.112
06/07/06	0.54	-0.616	0.641
06/12/06	2.29	0.829	0.415
06/14/06	0.25	-1.386	2.467
06/19/06	0.24	-1.427	2.596
06/21/06	1.68	0.519	0.112
06/26/06	0.38	-0.968	1.327
06/28/06	0.23	-1.470	2.735
07/02/06	0.33	-1.109	1.672
07/05/06	0.08	-2.526	7.344
07/10/06	0.57	-0.562	0.557
07/12/06	2.44	0.892	0.501
07/17/06	8.68	2.161	3.908
07/19/06	4.76	1.560	1.893
07/24/06	2.89	1.061	0.769
07/26/06	1.48	0.392	0.043
07/31/06	0.76	-0.274	0.210
08/02/06	1.21	0.191	0.000
08/07/06	0.45	-0.799	0.966

**CITGO AMMONIA
EFFLUENT CALCULATIONS**

Date	ppm-NH ₃ N = X	Y	(Y - μ_y) ²
08/09/06	0.48	-0.734	0.843
08/14/06	0.24	-1.427	2.596
08/16/06	0.16	-1.833	4.067
08/21/06	0.16	-1.833	4.067
08/23/06	0.33	-1.109	1.672
08/28/06	0.34	-1.079	1.595
08/30/06	0.26	-1.347	2.345
09/04/06	0.79	-0.236	0.176
09/06/06	0.34	-1.079	1.595
09/11/06	0.66	-0.416	0.360
09/13/06	1.40	0.336	0.023
09/18/06	0.12	-2.120	5.311
09/20/06	0.12	-2.120	5.311
09/25/06	0.24	-1.427	2.596
09/27/06	1.09	0.086	0.010
10/02/06	0.11	-2.207	5.719
10/04/06	0.12	-2.120	5.311
10/09/06	0.18	-1.715	3.606
10/11/06	0.21	-1.561	3.045
10/16/06	0.19	-1.661	3.404
10/18/06	0.48	-0.734	0.843
10/24/06	0.73	-0.315	0.249
10/25/06	1.06	0.058	0.016
10/30/06	0.90	-0.105	0.084
11/01/06	0.99	-0.010	0.038
11/06/06	1.02	0.020	0.027
11/08/06	0.54	-0.616	0.641
11/13/06	0.44	-0.821	1.010
11/15/06	0.31	-1.171	1.837
11/19/06	0.53	-0.635	0.671
11/20/06	0.49	-0.713	0.806
11/27/06	0.47	-0.755	0.882
11/29/06	0.46	-0.777	0.923
12/04/06	0.15	-1.897	4.332
12/06/06	0.38	-0.968	1.327
12/10/07	0.19	-1.661	3.404
12/11/07	0.14	-1.966	4.624
12/18/07	1.49	0.399	0.046
12/20/07	0.51	-0.673	0.735
12/25/07	0.33	-1.109	1.672
12/27/07	0.13	-2.040	4.948
01/01/07	0.38	-0.968	1.327
01/03/07	0.21	-1.561	3.045
01/08/07	0.24	-1.427	2.596
01/10/07	0.81	-0.211	0.156
01/15/07	0.45	-0.799	0.966
01/17/07	0.32	-1.139	1.752
01/22/07	1.08	0.077	0.012
01/24/07	2.80	1.030	0.715
01/29/07	1.30	0.262	0.006
01/31/07	6.26	1.834	2.722

CITGO AMMONIA
EFFLUENT CALCULATIONS

Date	ppm-NH ₃ N = X	Y	(Y - μ _y) ²
02/05/07	7.86	2.062	3.525
02/07/07	2.96	1.085	0.812
02/12/07	0.38	-0.968	1.327
02/14/07	0.49	-0.713	0.806
02/19/07	0.48	-0.734	0.843
02/21/07	1.36	0.307	0.015
02/26/07	0.17	-1.772	3.827
02/28/07	0.32	-1.139	1.752
03/05/07	0.14	-1.966	4.624
03/07/07	0.16	-1.833	4.067
03/12/07	3.71	1.311	1.270
03/14/07	2.54	0.932	0.559
03/19/07	1.72	0.542	0.128
03/21/07	0.86	-0.151	0.112
03/26/07	1.76	0.565	0.145
03/28/07	0.90	-0.105	0.084
04/02/07	0.55	-0.598	0.612
04/04/07	0.98	-0.020	0.042
04/09/07	0.74	-0.301	0.236
04/11/07	1.38	0.322	0.019
04/16/07	0.88	-0.128	0.097
04/18/07	1.59	0.464	0.078
04/23/07	1.27	0.239	0.003
04/25/07	8.01	2.081	3.597
04/30/07	11.80	2.468	5.216
05/02/07	2.43	0.888	0.495
05/07/07	1.70	0.531	0.120
05/09/07	2.38	0.867	0.466
05/14/07	3.01	1.102	0.842
05/16/07	2.55	0.936	0.565
05/21/07	4.72	1.552	1.870
05/23/07	2.77	1.019	0.697
05/28/07	1.78	0.577	0.154
05/29/07	1.79	0.582	0.158
06/04/07	6.70	1.902	2.951
06/06/07	4.66	1.539	1.835
06/11/07	2.12	0.751	0.322
06/13/07	3.50	1.253	1.142
06/18/07	3.86	1.351	1.361
06/20/07	4.11	1.413	1.511
06/25/07	4.94	1.597	1.997
06/27/07	3.77	1.327	1.306
07/02/07	2.64	0.971	0.619
07/04/07	1.36	0.307	0.015
07/09/07	2.28	0.824	0.410
07/12/07	1.90	0.642	0.209
07/16/07	2.77	1.019	0.697
07/18/07	3.22	1.169	0.971
07/24/07	7.16	1.969	3.184
07/25/07	5.80	1.758	2.476
07/30/07	5.89	1.773	2.525